

LECTURE NOTE
ON
PRODUCTION TECHNOLOGY

**Ganesh Institute of Engineering and
Technology**



SCTE&VT, BHUBANESWAR ODISHA

**3rd Semester Diploma in Mechanical Engineering
(As per Syllabus prescribed by SCTE&VT, Odisha)**

By

Subject Co-ordinator: Er. Ritesh Kumar Hui

Sr. LECTURER, AUTOMOBILE ENGINEERING

Metal Forming Processes

Metal forming process is a process where the work piece is reshaped into desired objects by the principle of plastic deformation . In this process the mass of the work piece remains unchanged. Example : Extrusion, Rolling

Extrusion:

Extrusion is a manufacturing process which involves forcing the work piece through a pre shaped die to create objects with a specific shape and profile. In extrusion process the billet is placed in a container, pushed through a die opening using a ram or dummy block.

Application of Extrusion:

The process of extrusion suits best to the non ferrous metals and alloys , although some steel alloys like stainless steel are also extruded. Extrusion of steel needs adequate lubrication around the billet . A coating of finely powdered glass over the surface of hot billet is utilized for this lubrication purpose.

Classification of Extrusion:

Extrusion is classified in general into four types. They are:

1. Direct Extrusion or forward Extrusion
2. Indirect Extrusion or Backward Extrusion
3. Impact Extrusion
4. Hydrostatic Extrusion

Direct Extrusion:

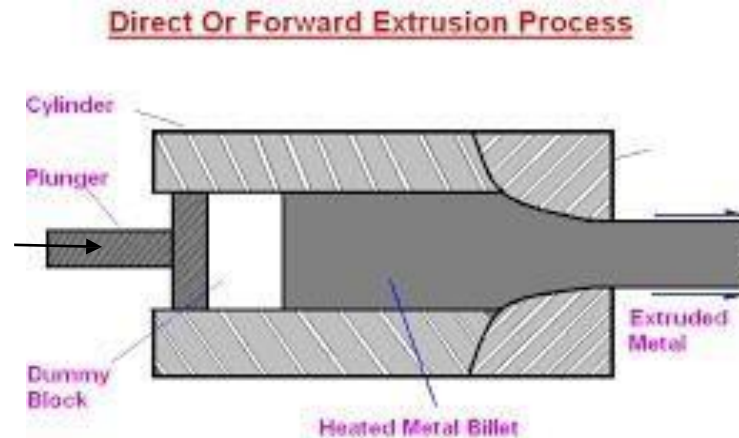

It is the most widely used method. The process is illustrated in the above figure. In this process the billet is heated to its forging temperature and fed into the machine chamber i.e the cylinder where pressure is applied to the billet with the help of the ram and the metal flows in forward direction i.e. same direction as that of the ram and comes out through the die opening. The overhanging extruded length is fed into a long support called the run-out table. The last 10% length of the billet is left unextruded and this portion is known as discard and contains surface impurities of the billet.

In forward extrusion, friction occurs between the heated metal and the cylinder walls due to relative motion between them. The problem of friction is severe in case of steel extrusion because of their high extrusion temperature.

To reduce these friction lubricants are used. At lower temperature a mixture of oil and graphite is generally used. For steel extrusion, finely powdered glass is used as lubricant.

To reduce the damage to the equipment extrusion is finished quickly and the cylinder is cooled before further extrusion.

Indirect Extrusion or Backward Extrusion:

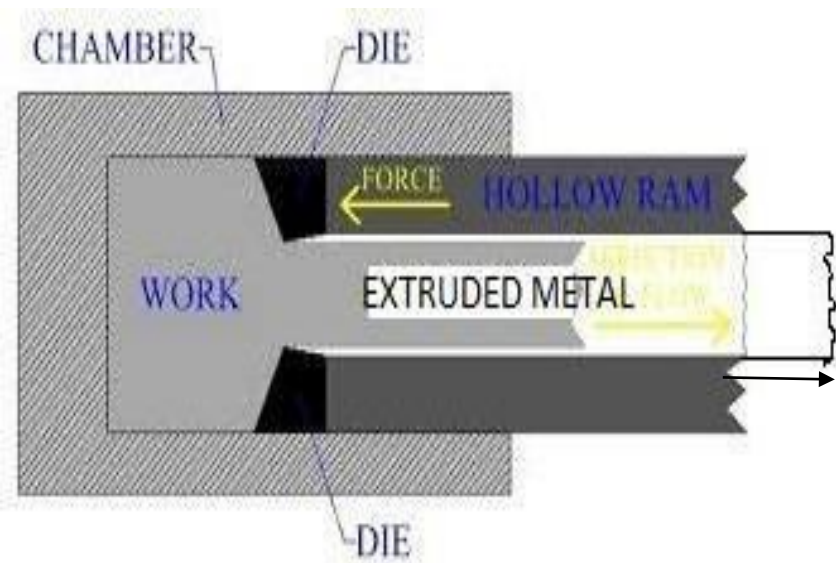

For this type of extrusion a hollow ram or plunger is used. In this case the plunger presses the billet against the back wall of the closed chamber and the metal is extruded back into the plunger through the die.

It is termed backward because of the opposite direction of flow of metal to that of Ram movement.

As the billet does not move inside the chamber, there is no friction between them. Less force is needed in this method in comparison to the direct extrusion.

Better surface quality is achieved in this process as no heat cracking happens between the billet and extrusion cylinder interface.

The disadvantages of this process are:

- A more complicated type of equipment is required as the plunger becomes weak.
- In supporting the overhanging extruded part coming out of moving RAM.

Impact Extrusion or backward cold extrusion:

This method is chiefly used for making small work pieces from ductile material. The material is placed in the position into a blind die and a ram with clearance is forced in to the die, making the metal to flow plastically around the ram. Because of the impact force the side walls go straight along the punch though they are not confined.

With the help of this process, collapsible medicine tube and toothpaste tubes are produced. Lead, aluminum, copper, tin and other soft metals are used in this process.

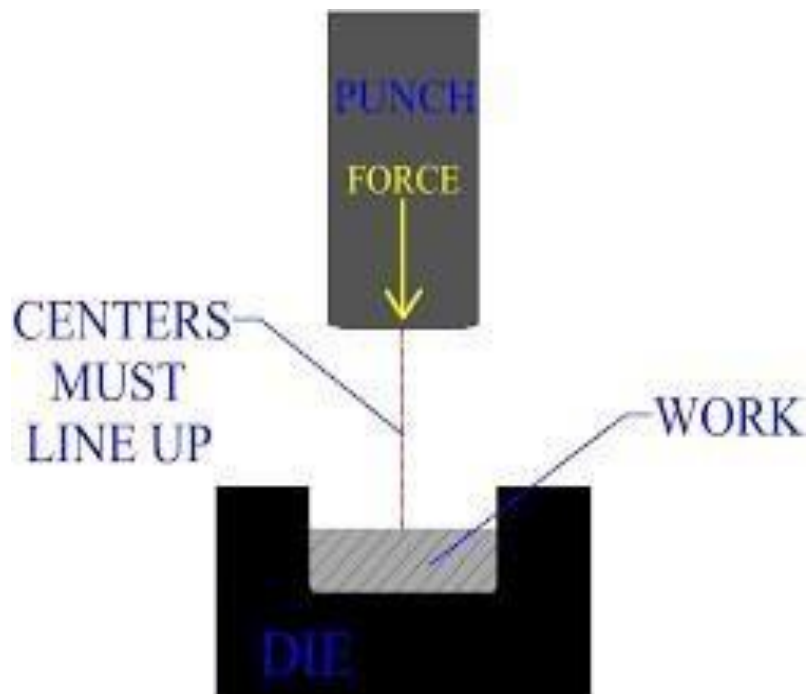

ROLLING

Rolling is a metal forming process in which the cross-sectional area is reduced by passing the work piece (ingot) through a pair of rolls.

In rolling process the thickness of the ingot reduces and length of the ingot increases by compressive force applied by rolls.

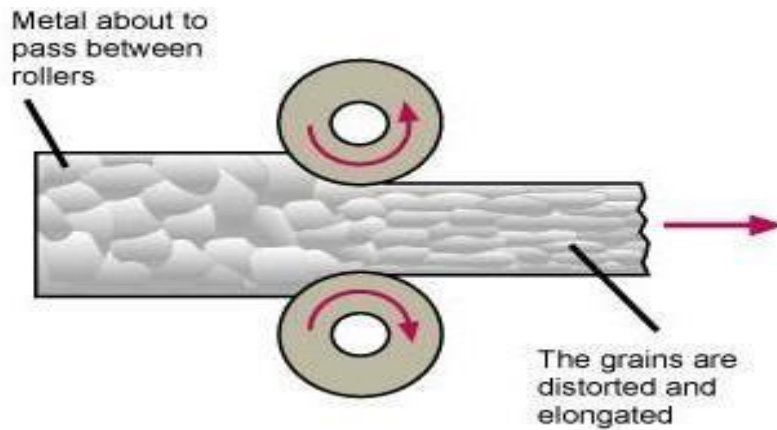

3DVIEWOFROLLING

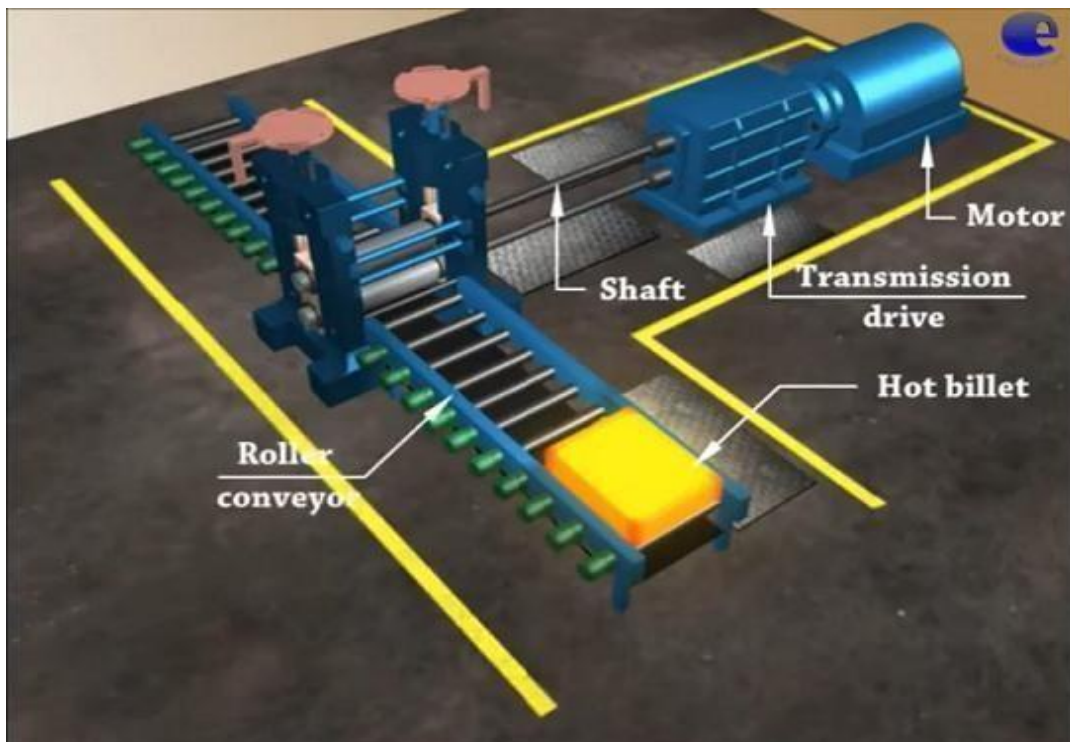

CLASSIFICATION OF ROLLING:

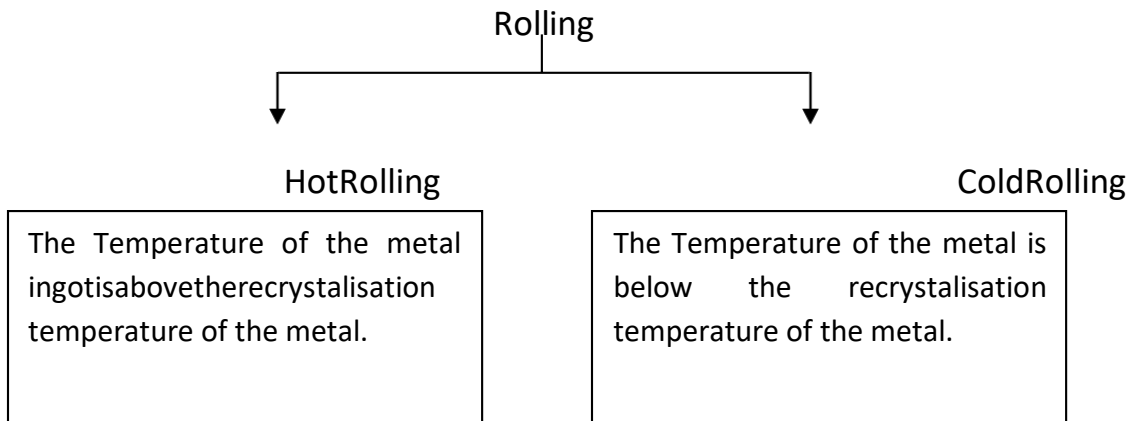

Difference between hot rolling and cold rolling

<u>Hot Rolling</u>	<u>Cold Rolling</u>
1. Hot rolling is conducted above recrystallisation temperature of metal i.e 0.3 to 0.5 of melting point of metal.	1. Cold rolling is conducted below recrystallisation temperature of metal.
2. No strain hardening occurs. Large reduction of cross sectional area can be obtained.	2. Strain hardening occurs. Strength increases but ductility decreases.
3. Yield strength reduces and ductility increases for which plastic deformation occurs by applying less amount of power.	3. Strain hardening and high yield strength limited deformation in one pass.
4. Coarse structure of cast ingot is converted into a fine grained structure. Fine grained structure improves physical properties.	4. No scale formation or oxidation of metal surface occurs. Results in good surface finish.
5. Poor control over dimension due to thermal expansion.	5. No thermal expansion.

Limitation:

- 6. Oxidation, scale formation on surface reduces surface finish.
- 7. Handling is tough.

Limitation:

- 6. No working of low ductility metal.

Rolling mills may be classified according to the number and arrangement of the rolls.

TYPES OF ROLLING MILLS:-

- 1. Two high rolling mills
 - a. Nonreversing
 - b. Reversing
- 2. Three high rolling mills
- 3. Four high rolling mills
- 4. Tandem rolling mills
- 5. Cluster rolling mills
- 6. Planetary rolls

Two high rolling mills:-

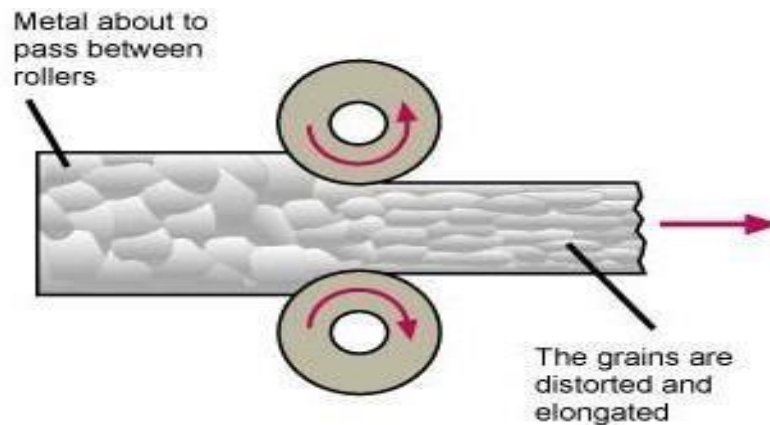

TWO HIGH NON REVERSING ROLLING MILL:

1. Both the rolls rotate in opposite directions to one another as shown in the figure. The direction of rotation is fixed, cannot be reversible thus the work can be rolled by feed from one direction.
2. The space between the rolls can be adjusted by raising or lowering the upper roll. The position of lower roll is fixed.
3. This mill is used where the bar has to pass once and in open train plate mill.

TWO HIGH REVERSING ROLLING MILL:

1. In this type of rolling mill there is a drive mechanism which can reverse the direction of rotation of the roll.
2. Because of this drive mechanism the metal may pass back and forth through the rolls several times.
3. This type of mill is used in blooming and slabbing mills and for roughing work in plate, rail structure and other mills.

THREE HIGH ROLLING MILLS:

It consists of a roll stand with three parallel rolls one above the other. adjacent rolls rotate in opposite direction.

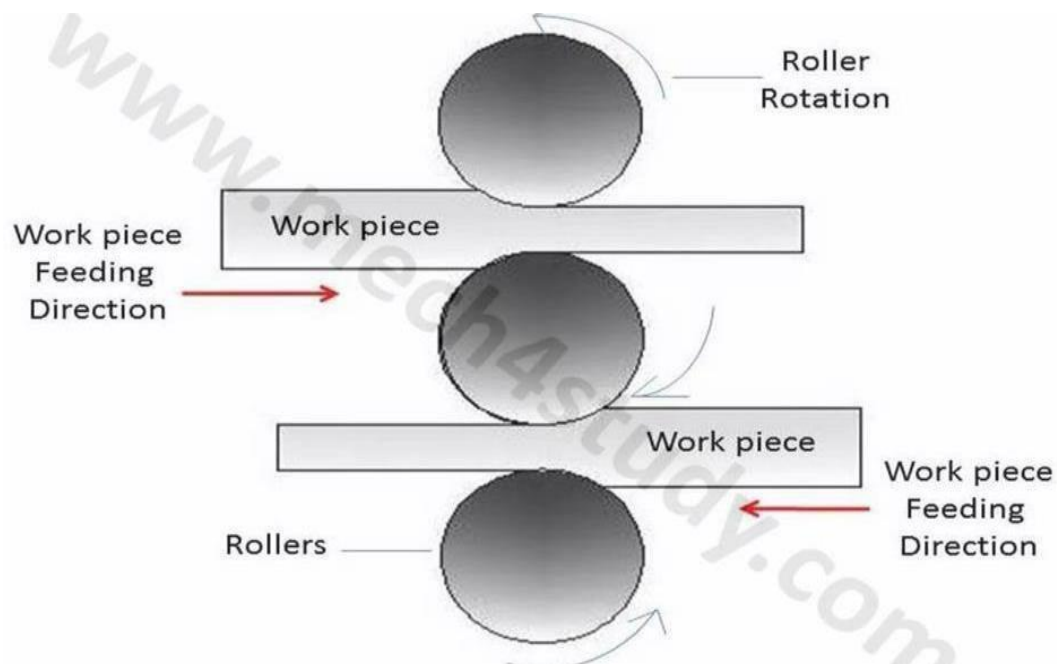

THREE HIGH ROLLING MILL

3DVIEWOF3HIGHROLLINGMILL

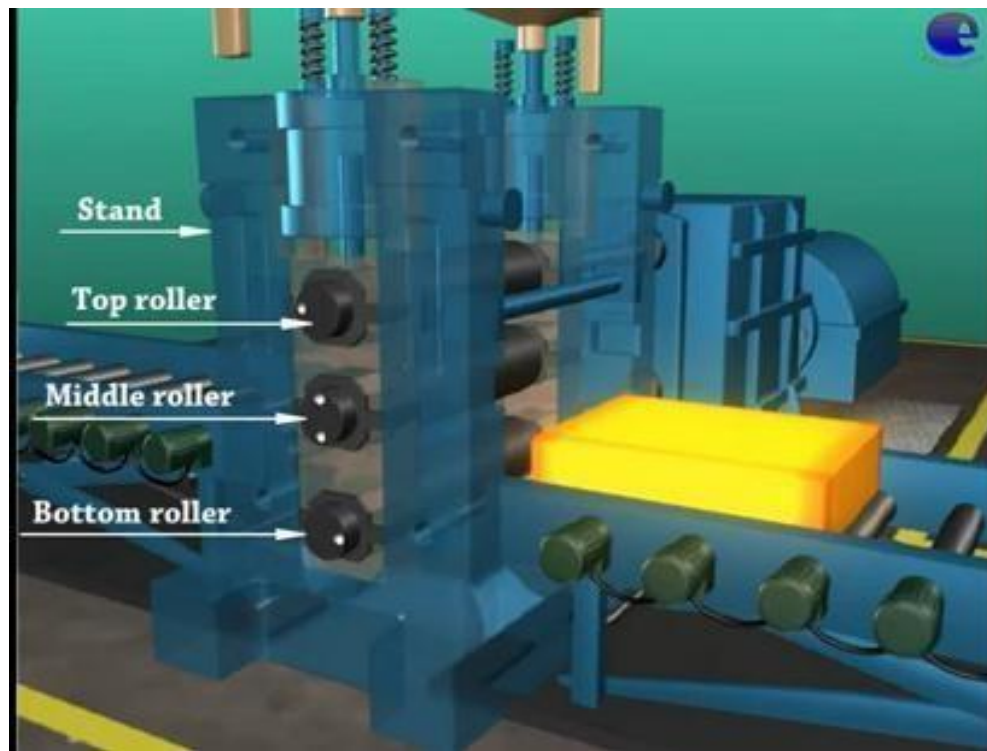

1. This arrangement is used for rolling of two continuous passes in a rolling sequence without reversing the drive.
2. First of all the metal has passed through the bottom & the middle roll in one direction, the end of the metal is entered into the other set of the rolls for the next pass..
3. For this purpose a mechanically operated lifted tables are used to bring the metals to the level of the rolls. Since the rolls run in one direction only a much less powerful motor and transmission system is required .

FOURHIGHROLLINGMILLS:

The four high rolling mills has a rolling stand with two small size rolls & two big size rolls. These four rolls placed parallelly one above the other . The work piece passes through the two small rolls & the big size rolls works as backup rolls for providing the necessary rigidity. It works like two high rolling mills.

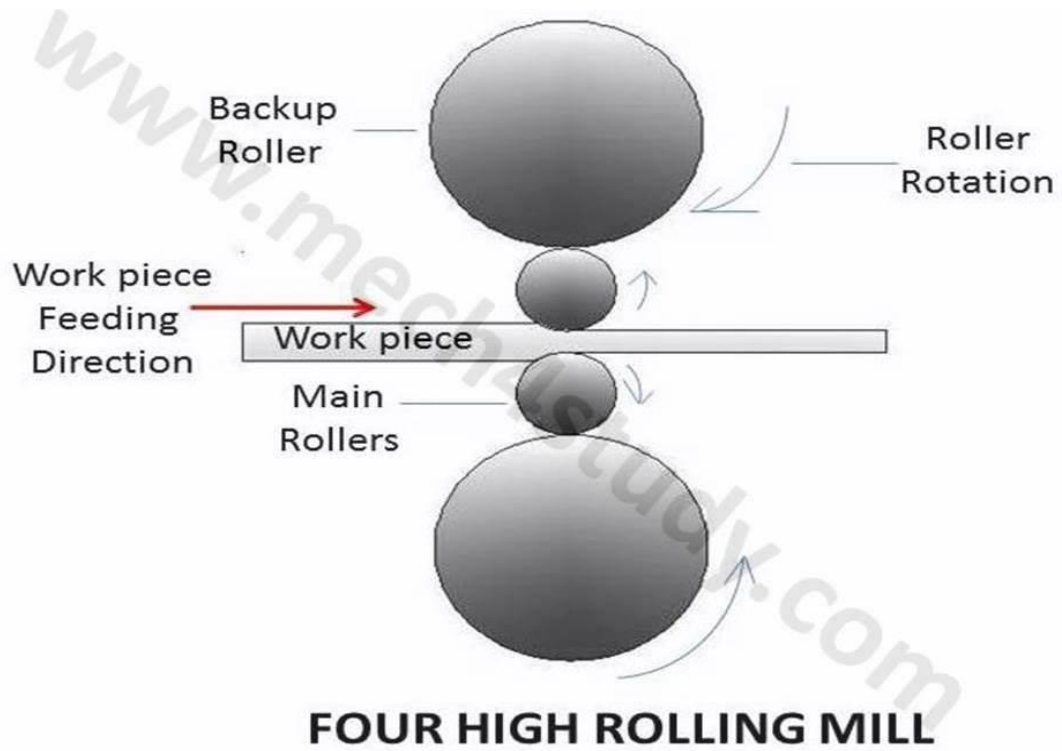

3DVIEWOF4HIGHROLLINGMILL

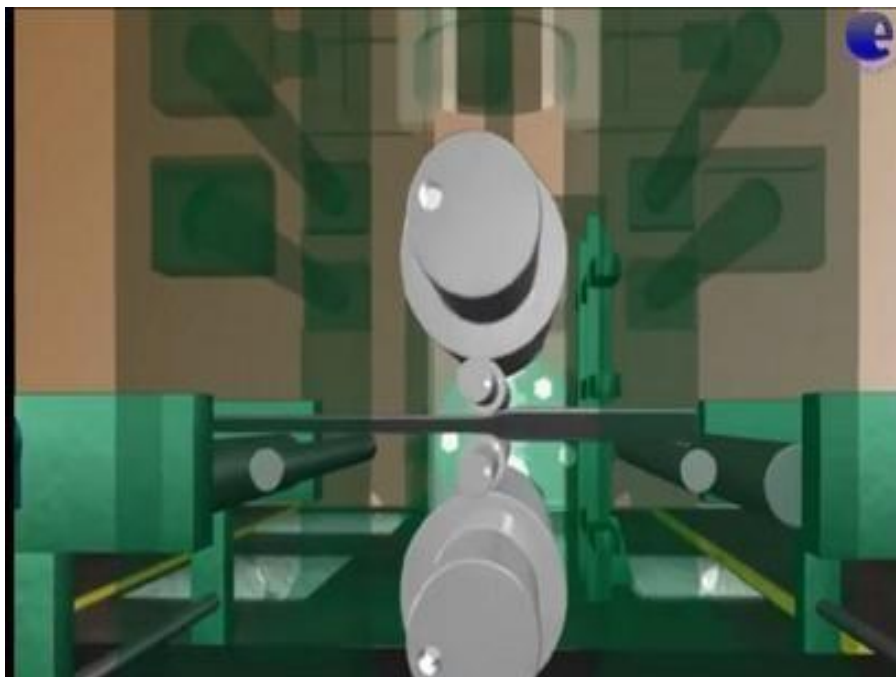

TANDEMROLLINGMILLS:

The tandem mill consist of 3 to 6 mills stands arrange in series to progressively reduced the thickness of the strip in a single pass. The advantages of the Tandem Rolling process include cost reduction and improve

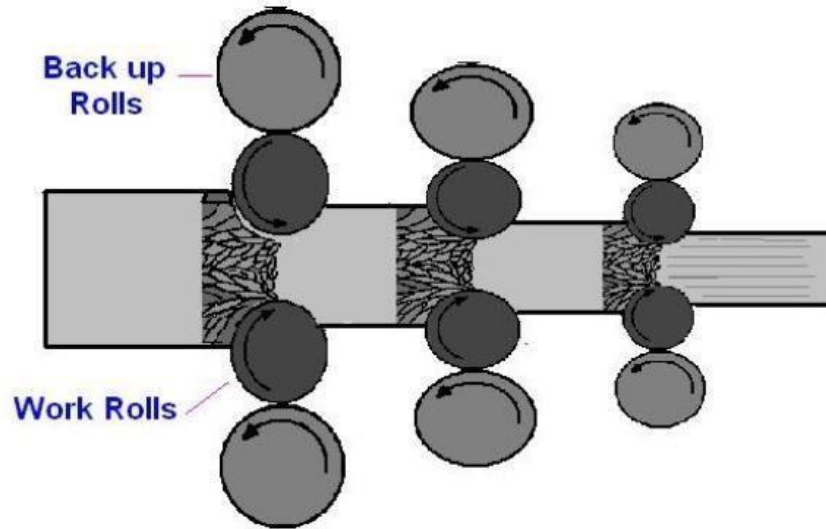

CLUSTER ROLLING MILLS:

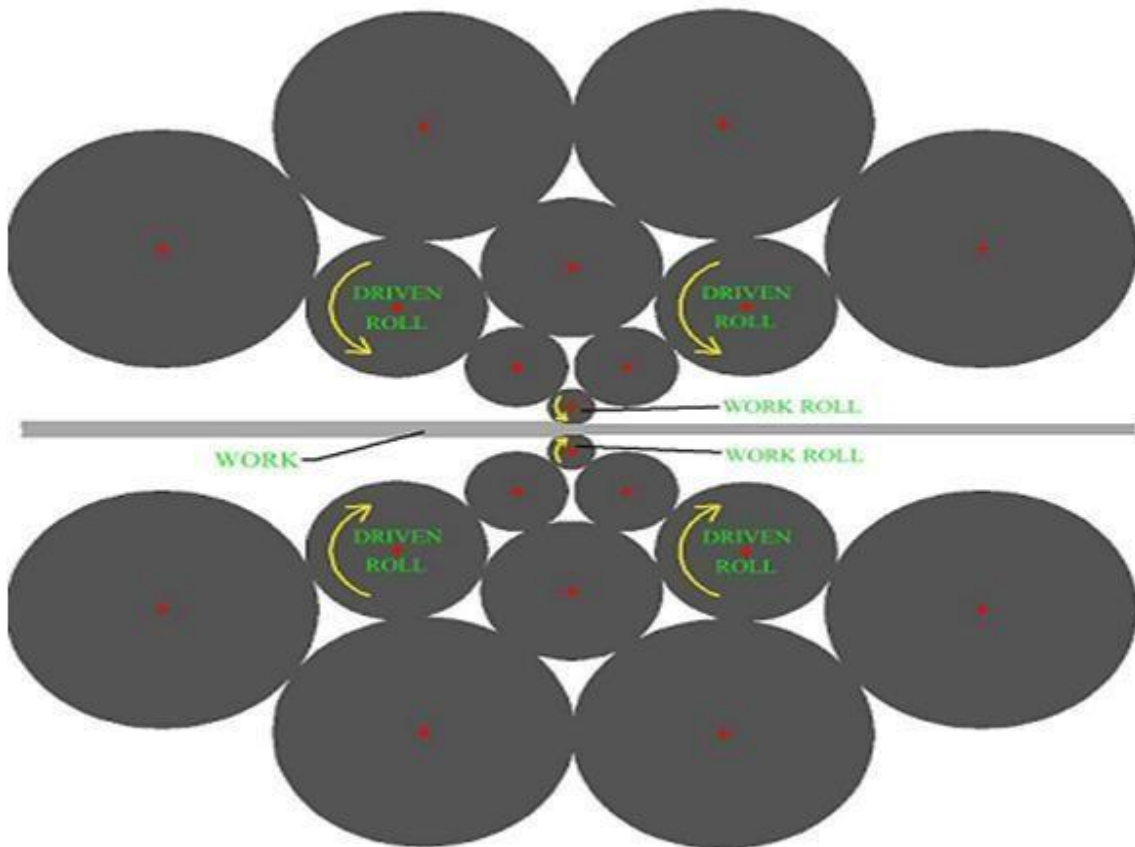

1. It consists of two working rolls of smaller diameter and a number of backup rolls of larger diameter.
2. The number of backup rollers may go as high as 20 or more depending upon the amount of support needed for the working rolls during the operation.
3. This type of mill is generally used for cold rolling.

4. Clustermills are used to reduce the thickness of stainless steel, high carbon steel or any other high strength alloy steel.
5. The main advantage of cluster mill is the backup roll takes out a large amount of heat from the working roll and the work piece.

PLANETARY:

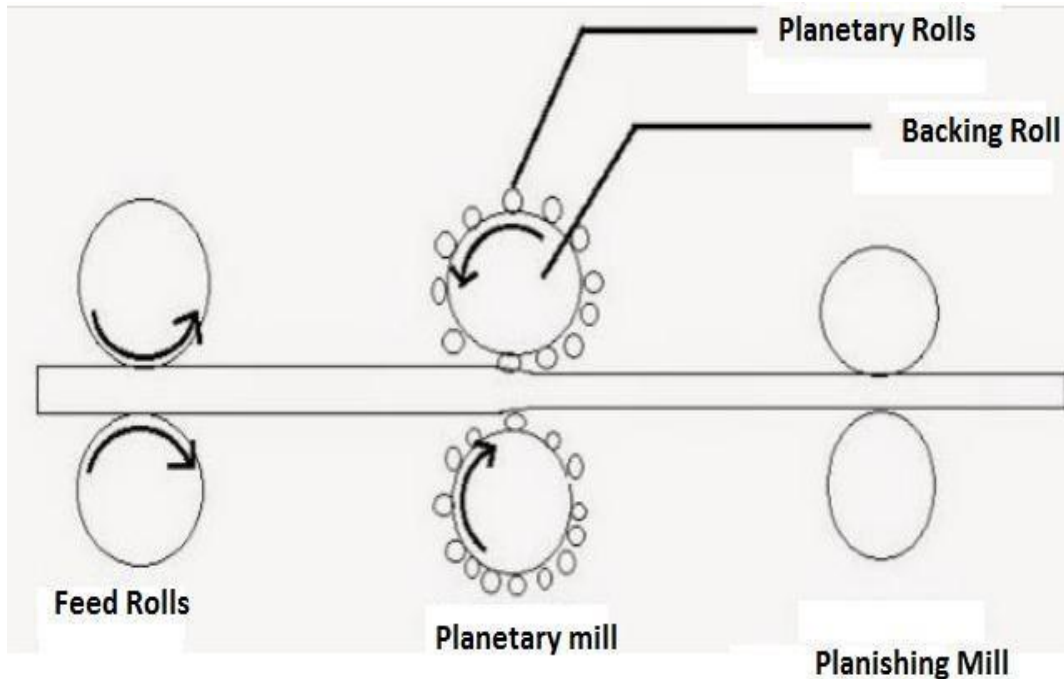

[Planishing is a metal working technique that involves finishing the surface by finely shaping and smoothing]

1. In planetary rolling mill a no of rotating wheels are used as workroll instead of a single small roll, are fixed to the large backup roll.
2. This mill can be used to roll all metals but it is specially useful for those which has low ductility.
3. In this mill the metal at lower than its critical temperature can be entered for rolling which reduces scale formation.

WELDING

Welding is the process of joining similar or dissimilar metals and plastics without using fasteners and adhesives.

This process is basically of two types.

- i) Fusion Welding
- ii) Pressure Welding

Fusion Welding:

- In this process the temperature of end part of base metals which are to be joined are raised to their fusion point by application of heat.
- As a result of which they form a sort of pool of homogeneous molten metal at the ends to be joined.
- Sometimes a filler metal (wire or rod) which has nearly the same composition of the parent metals are used to supplement the pool.
- After solidification the two ends joined permanently.

Pressure welding:

- In this process the ends of the metal pieces are heated to their plastic state and then external pressure is applied to join them.

Classification of welding according to source of energy employed to heat the metal

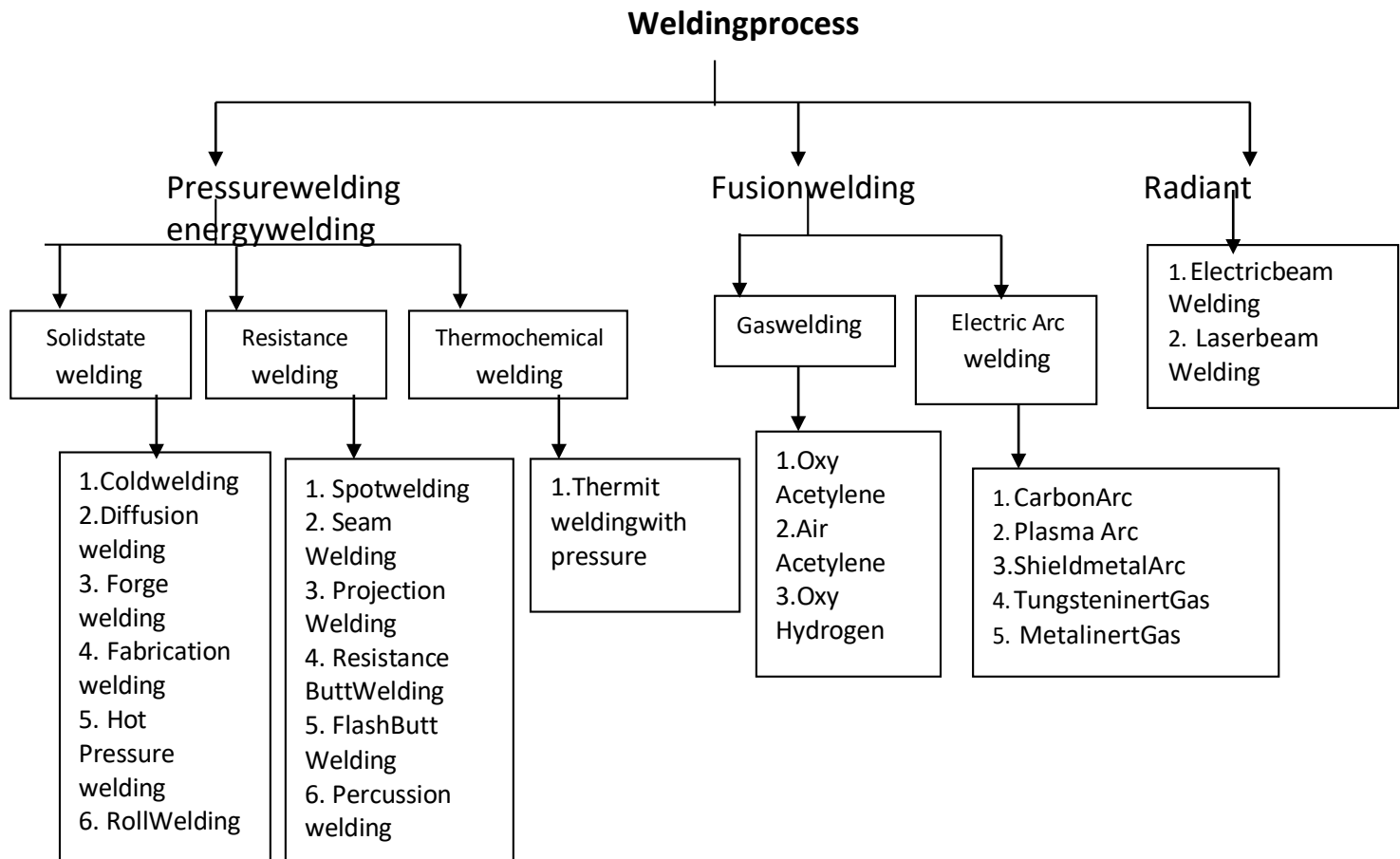

WELDING FLUX:

- Welding flux is a shielding agent and sometimes acts as a prime anti-oxidizing agent which prevents the interaction of surrounding medium (like air) and reduces oxides respectively.
- During the welding process, as the temperature of base material as well as filler material increases in a very short time, it leads to metal oxide formation by interacting with surrounding air. This oxide layer reduces the weld strength. The formation of sulfides and nitrides also hurts the weld's strength.

Hence flux material is used either to shield the welding area to prevent formation of oxides or to reduce the oxides formed.

- In addition to prevention of formation of oxides weld flux also,
- Creates a protective slag over the molten metal.
- Removes impurities from the molten metal.
- Reduces spatter.
- Prevents hardening by slowing down cooling time.

Because of its greater tolerance for base plate contamination, flux cored welding requires less pre-cleaning than MIG.

- Deposition rate is up to four times greater than stick welding.
- The use of self shielded electrodes eliminates the need for flux handling or gas apparatus for which it is convenient to use in outdoor construction.

Self shielded --- core provides ingredients for shielding.

Gas shielded --- uses external shielding gases.

Gases for shielding are CO_2 , Ar, mixture of two.

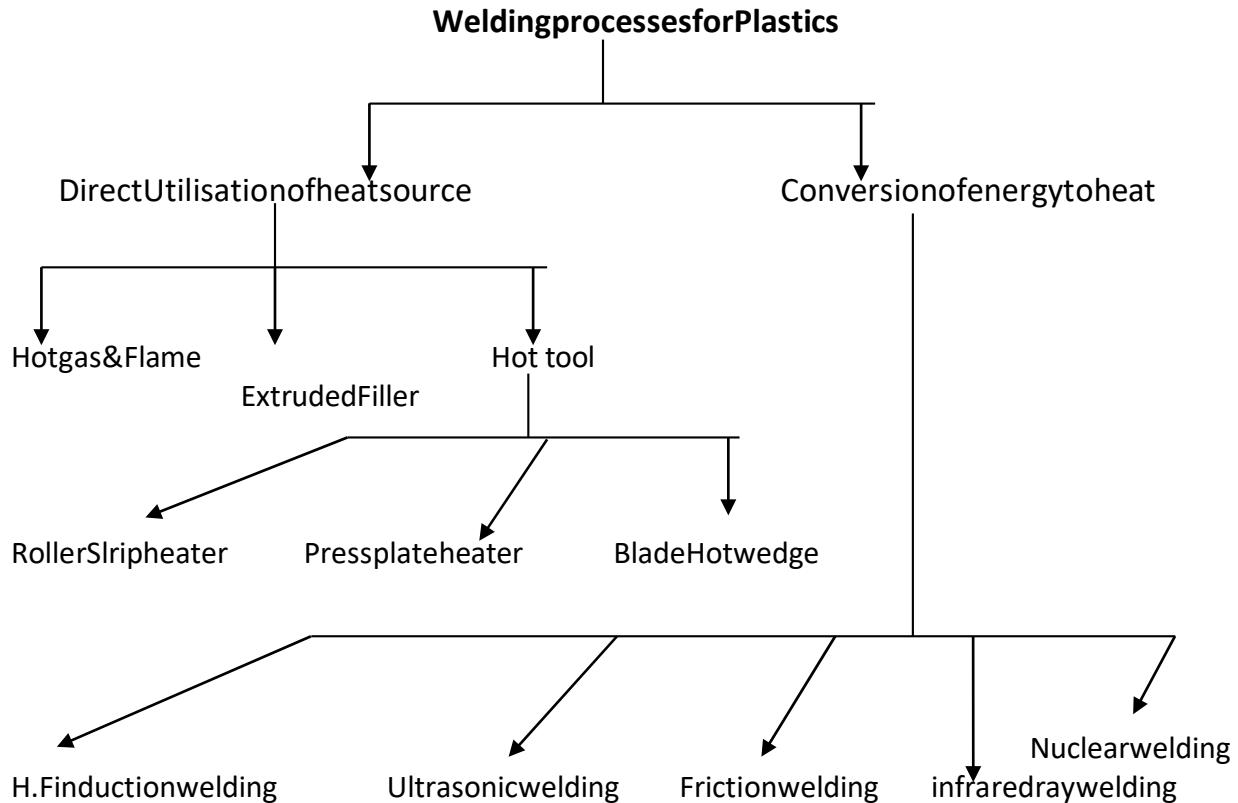

OXYACETYLENE WELDING

Oxy-Acetylene welding is one type of oxy-fuel welding. This welding can be used for welding almost all metals and alloys used in engineering field.

Equipments and accessories required for oxy-Acetylene welding

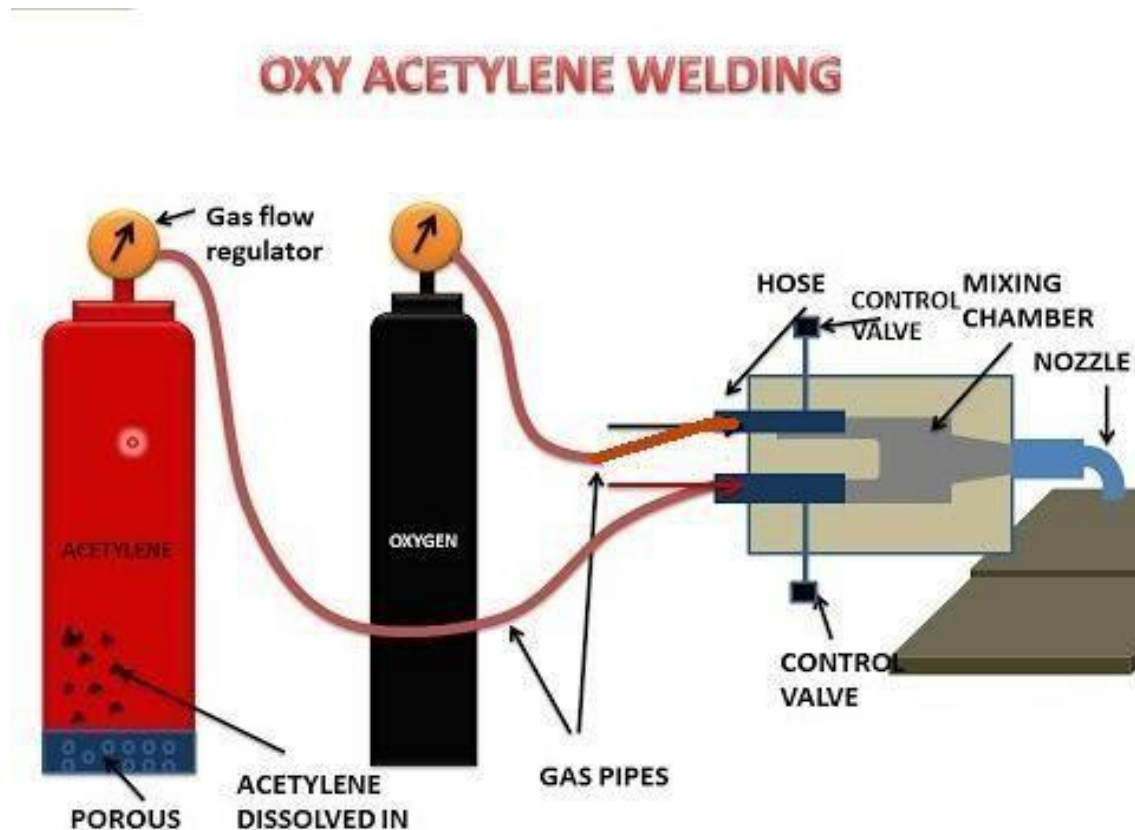

Equipment:

1. Oxy cylinder (painted black)
2. Acetylene cylinder (painted maroon)
3. Blow pipes and torches
4. Pressure Regulator

1. Oxygencylinder(paintedblack)

In this cylinder oxygen is filled at a pressure of 125 kgs to 140 kgs per square centimeter.

2. Acetylenecylinder(paintedmaroon)

In high pressure system, acetylene cylinder carries porous mass inside, soaked in acetone, which has a capacity to dissolve 25 times its own volume of acetylene for every atmosphere of pressure applied.

In low pressure system, acetylene is drawn from a low pressure acetylene generator.

3. Blowpipesandtorches

The high pressure system blow pipe has two different passages which are connected to oxygen and acetylene hose pipe separately. The blow pipe or torch contains a chamber where both these gases are mixed and then driven out through the orifice of the blow pipe nozzle or tip. The low pressure blow pipe works on the principle of an injector.

4. PressureRegulator

Pressure regulators are fixed on the top of the gas cylinders and carry a reducing valve to reduce their pressure before feeding to the blow pipe. This pressure is regulated according to requirement by adjusting the spring pressure on the diaphragm by means of pressure regulating screw.

Two pressure gauges are fitted to two chambers, one before the diaphragm, shows pressure inside the cylinder and the other after the diaphragm, shows working pressure at which the gas is being drawn for operation.

Two stage regulators are preferred to one stage regulator. In this type pressure drop in first stage is fixed where the desired drop is regulated in the second stage.

ARC WELDING

- It is a fusion welding process where the heat is generated by the application of arc.

Electric arc welding

- In Electric Arc welding the end of the metal pieces to be joined are heated locally to the melting temperature, by creating an electric arc and then allowed to solidify to form the welded joint.
- The arc is a flame of intense heat, generated by passing electric current through a highly resistant air gap between the electrode and the workpiece.

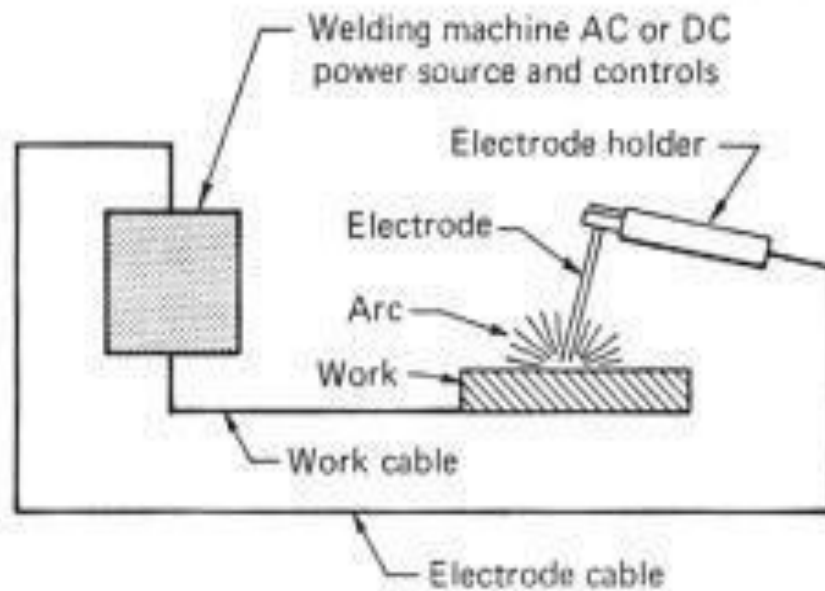

Different Arc Welding processes are:

- Shielded Metal arc welding
- Carbon arc welding
- Tungsten inert gas welding
- Metal inert gas welding

Shielded metal arc welding

In this process a metal electrode is used and the arc is maintained between this electrode and the workpiece, which respectively form the two terminals.

The metal electrode is coated with flux which produces a gas to shield and protect the welding area from atmospheric air. In some cases it also carries certain alloying elements which promote conduction of electric current and stabilize the arc.

- Both alternating current (A.C) and direct current (D.C) are used for arc welding.
- For A.C arc welding a step-down transformer is used which receives current from the supply mains at 400-440 volts and transforms it to the required voltage for welding i.e 80-100 volts.
- Application: it is used for welding of steel and cast iron.
- This welding is not used to weld copper metal.

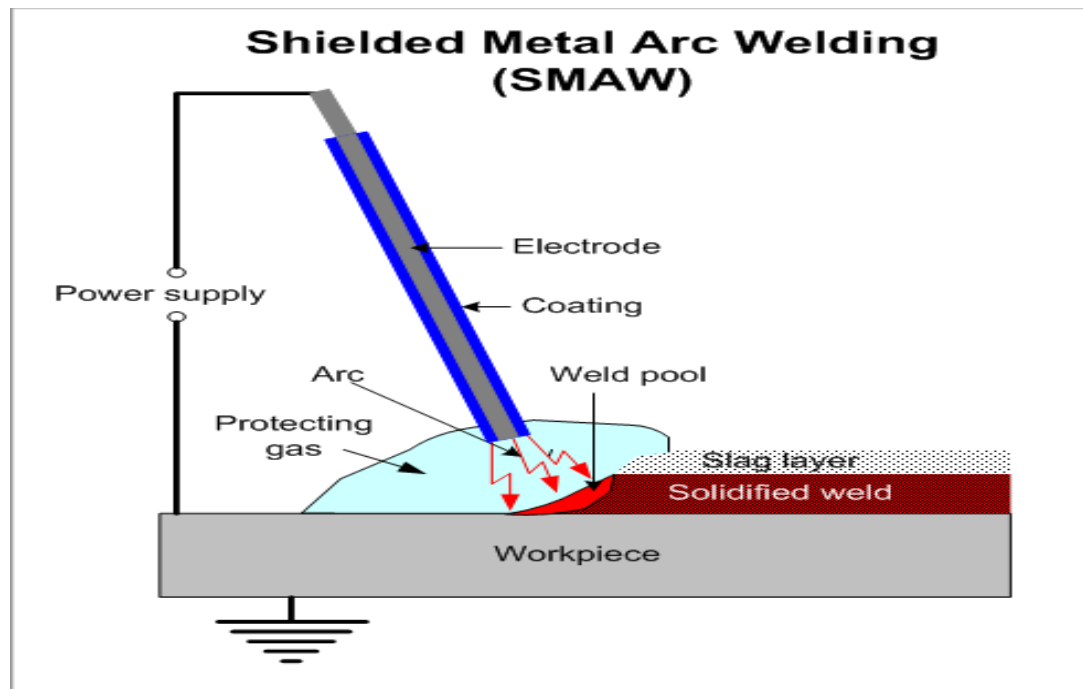

Carbon arc welding

- Carbon arc welding is a fusion welding process where consumable carbon electrode is used. non
- Only D.C. is used in carbon arc welding process.
- The negative terminal of the supply is connected to the carbon electrode and the positive terminal to the workpiece.
- A flux is used to prevent the weld metal from picking up carbon from the fused electrode.
- Application: this welding is used for joining steel sheets.

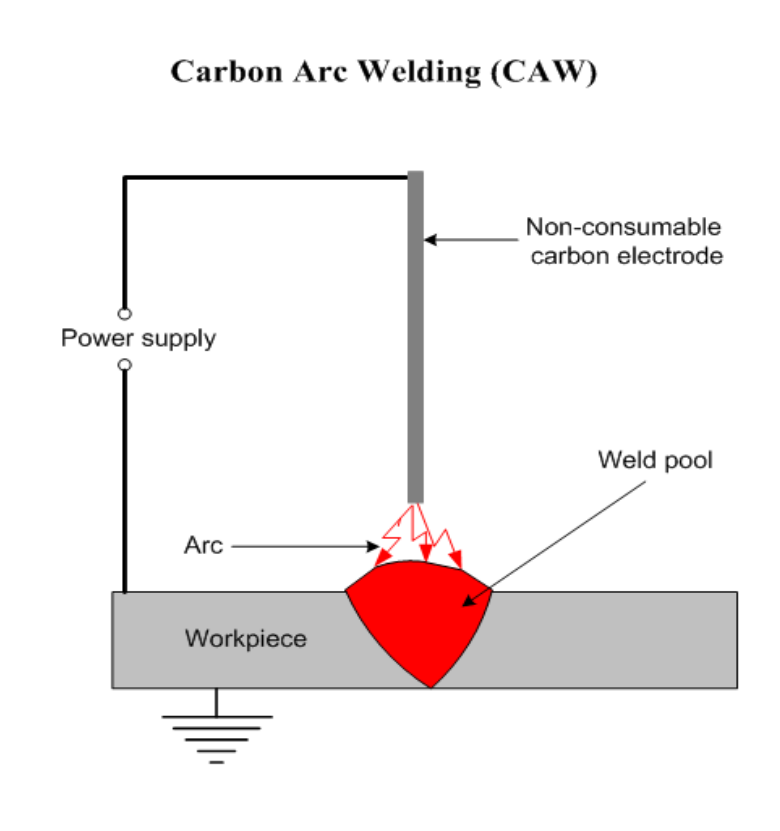

Arcweldingelectrodespecification:-

Electrode:-

It is a piece of wire rod (of metal or alloy) with or without flux coated material which carries current for welding.

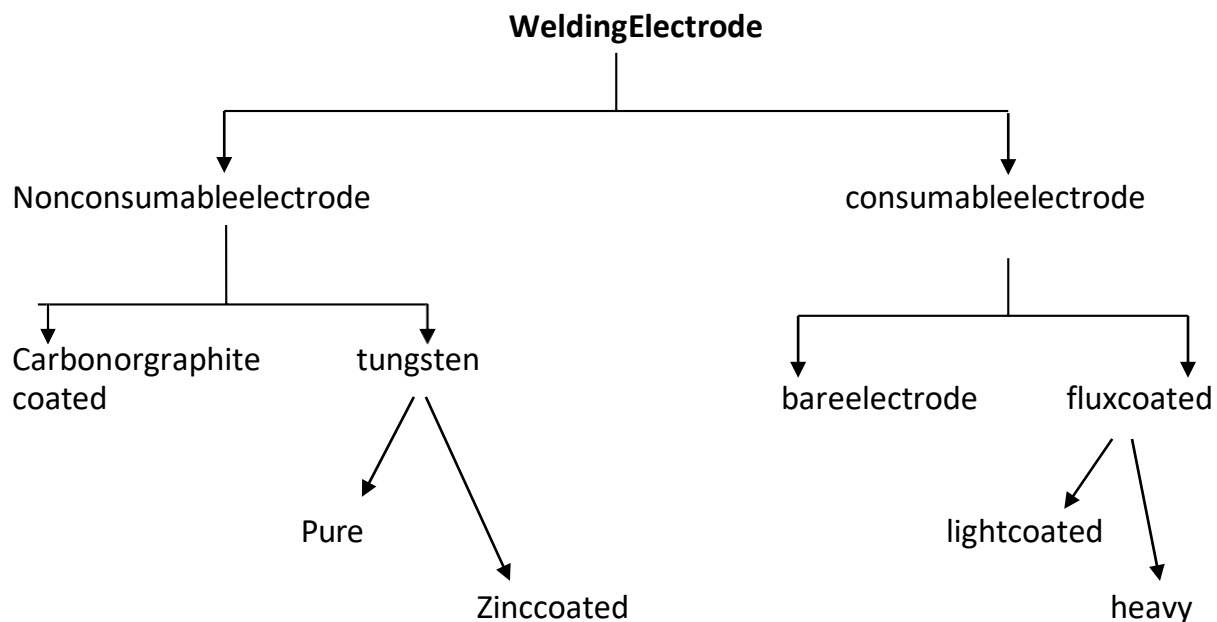

Consumableelectrode:-

1. Have low melting point.
2. When arc is generated between electrode and work piece the tip of the electrode starts melting and converted into droplets which transfer to the work piece.
3. These droplets transferring to the work piece gets deposited there and produce large heat so the thermal efficiency of consumable electrode arrangement is higher (85%) as compared to non-consumable electrode welding arrangement.

Bareelectrodes:-

1. It is made up of metals or alloys but without flux coating.
2. It does not prevent to oxidation or atmospheric contamination for which the joint will be weak and low ductile so it is used for minor repairs where strength is not dominant.

3. It has poor weld quality.
4. Arc is unstable.
5. Improper metal transfer.
6. It is noiseless.

Flux coated electrode:-

1. It prevents to the oxidation and to the atmospheric contamination by creating a gaseous shield around the arc.
2. Better arc
3. Stable arc
4. Better welding quality

Light coating:-

These electrodes having coating parameter of 1.25 Ex: cyto blast

Heavy coating:-

Coating parameter of 1.6 to 2.2.

ELECTRODE CLASSIFICATION AND CODING:

According to ISI coding system an electrode is specified by six digits with a prefix letter M, which indicates its suitability for metal-arc welding. These six digits stand for the following:

1. First digit:

Numbering from 1 to 8. Each number stands for a particular type of covering provided on the electrode.

2. Second digit:

It also carries numbers from 1 to 6 and each number represents a particular position or positions of welding in which the electrode can be used.

3. Third digit:

May carry any number from 0 to 7. Each number represents a particular current condition suitable for that particular electrode.

4. Fourth digit:

indicates the minimum tensile strength of the weld metal. It may carry any number from 1 to 5 and each number represents a particular tensile strength in kg/cm².

5. Fifth digit:

It indicates the percentage elongation of deposited weld metal in tensile testing. Different percentages are represented by numbers from 1 to 5.

6. Sixth digit:

It indicates the minimum impact value of the weld metal. Different values are represented by numbers from 1 to 5.

VARIOUS RESISTANCE WELDING PROCESSES

SPOT RESISTANCE WELDING

- This welding process is used for making lap welds in thin sheets (up to a maximum thickness of 12.7 mm) using the principle of resistance welding.
- In this welding process one end of the secondary winding of the transformer is connected to the upper electrode E1 carried in the movable copper or bronze arm A and the other end to the lower electrode E2 mounted on the fixed arm B.
- The metal sheets S1 and S2 are held and pressed between the electrodes and a strong current at low voltage is applied.
- Developed resistance by the sheet metals to the flow of this current causes heat and raises the temperature at the contact surfaces to their fusion point and the weld is completed under the contact pressure of the electrodes.

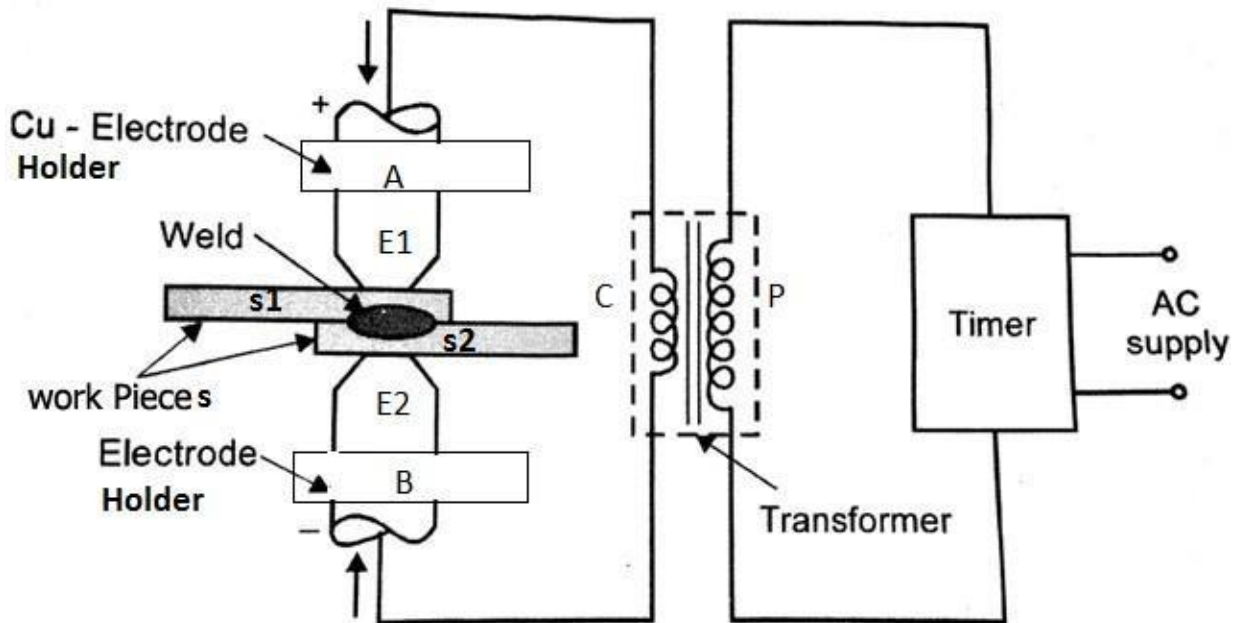

RESISTANCE BUTT WELDING

- Butt welding is also known as upset welding . It is used to join metal pieces end to end.
- In butt welding the metal pieces usual bars and rods of the same cross section are held in suitable clamps or vices with their prepared ends abutting against each other the developed resistance of flow of current depends on the projected lengths of the metal pieces and their cross sections. The projected length is to be adjusted to provide sufficient resistance to generate the desired amount of heat at the joining ends.
- The clamps either form the electrodes themselves or are fitted with separate electrodes in them.
- One of these lamps is rigidly fixed to the frame of the welding machine and the other is mounted on a movable slide operated by a handle lever

(for large machines) or a spring (for small machines capacity up to 12.7 mm).

- After butting the ends together the current is switched on and the contacting surfaces heated to the fusion point.
- At this moment additional mechanical pressure is applied by means of the hand lever or the spring attachment and this completes the weld.
- A trip switch automatically breaks the circuit as soon as the upset setting is over.
- Buttwelding is used for welding of tubes, wires, rods, chains made up of metals having high range of electrical conductivity such as Cu.

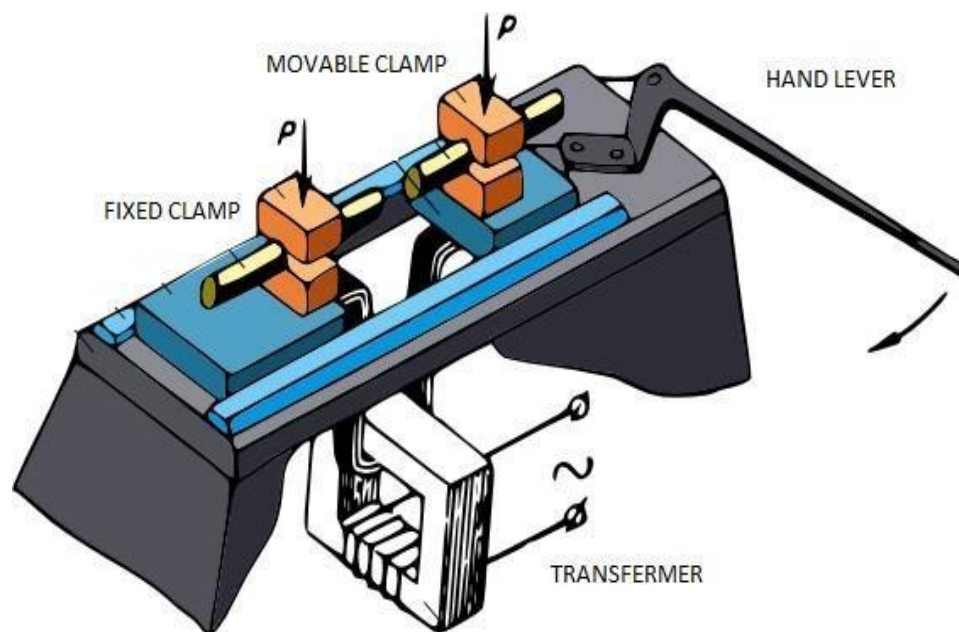

RESISTANCE FLASH WELDING

- Flash welding is used for joining metal pieces end to end. It replaces the butt welding method for welding articles having thin cross-section. It is also used to weld thick sections.
- In this method, first the current is switched on and then the ends of the pieces to be welded are slowly brought closer until they finally come in contact with each other.
- Once the ends come in contact with each other they force the generated heat to localise at the ends as a result of which the temperature raises to fusion point.
- At this moment the ends are pressed against each other by applying mechanical pressure.
- This force then molten metal and slag to be squeezed out in the form of sparks enabling the pure metal to form the joint and disallowing the heat to spread back.

ADVANTAGES AND DISADVANTAGES OF FLASH WELDING OVER SIMPLE BUTT-WELDING:

ADVANTAGES:

- It is comparatively much quicker than butt-welding.
- On account of only a small portion of the metal being heated the current consumption is less as compared to butt-welding.
- A flash welding joint is stronger than the butt-welding joint.
- The end faces of the metal pieces need not be squared which is a primary requirement in butt-welding.
- Length and alignment of workpieces is maintained to a high degree of accuracy.

DISADVANTAGES:

- During flashing particles of molten metal are thrown out, which may enter into the slideways and insulation, etc. this needs periodic maintenance of machine and replacement of insulation.
- Operator has to take enough care against possible fire hazard due to flashing.
- Additional stock has to be provided to compensate the loss of metal during flashing and upsetting. This adds to the cost of product.
- Cost of removal of flash and upset metal by trimming, chipping, grinding etc. further adds to the product cost.

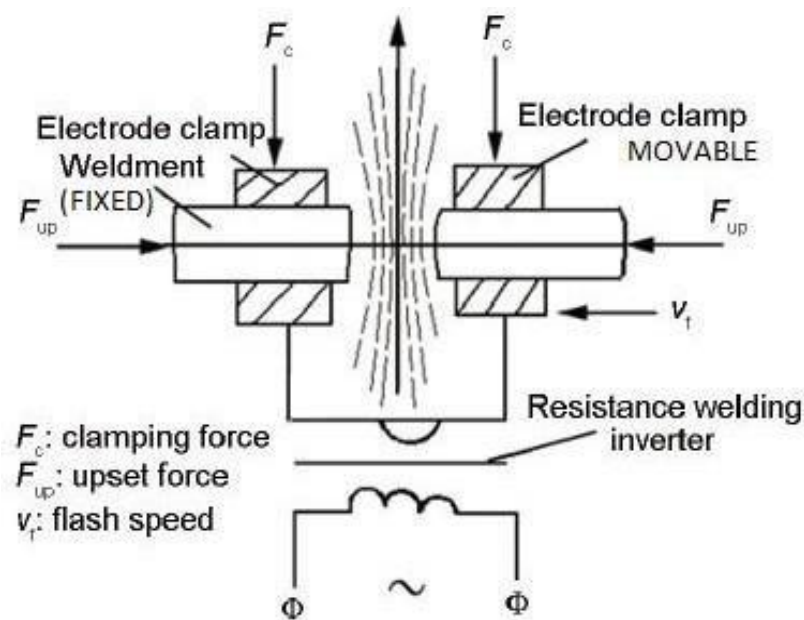

RESISTANCE PROJECTION WELDING:

- It is a multi-spot welding technique.
- The pieces to be welded are arranged between two flat copper electrodes which exert pressure as current flows.

- In this welding process , projections at the desired location on the surface of one of the workpieces are located. thus the surfaces of the workpieces are in contact with each other at the projection. As per current is switched on the projections are melted and the workpiece pressed together to complete the weld , by pressing the upper electrode downwards.

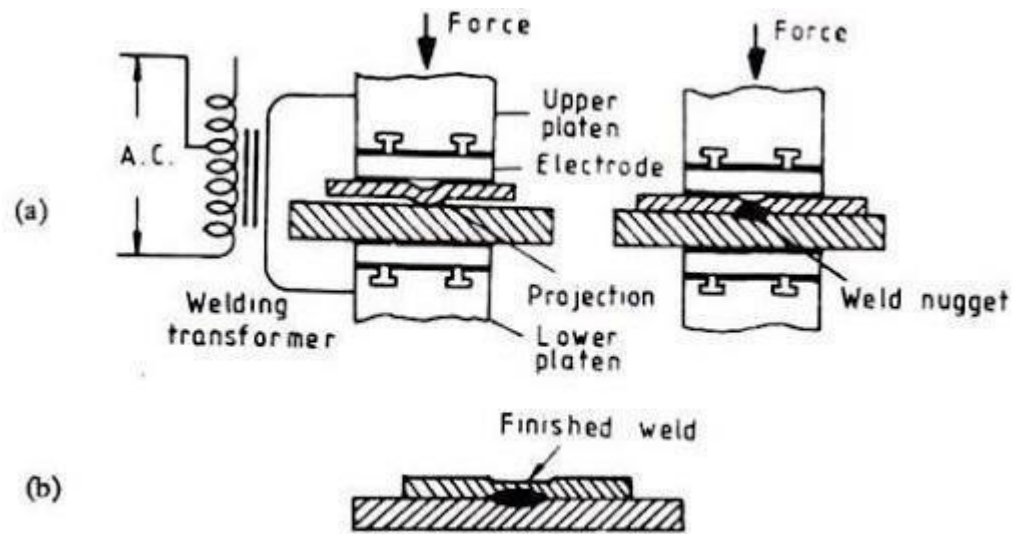

Projection welding (a) Setup (b) Finished weld.

RESISTANCE SEAM WELDING:

- It is similar to spot welding with difference that the electrodes are in the form of rotating rollers and w/p moves in direction perpendicular to roller axis.
- In this welding the current is switched on and the metal pieces pushed together to travel between the revolving electrodes. The metal between the electrodes gets heated to welding heat and welded continuously under the constant pressure of rotating electrodes as it passes between them.

- The welding is usually done under water to keep the heating of welding rollers and the work to a minimum value to give lower roller maintenance.
- Welding current range from 2000A to 5000A while the force applied to the roller may as high as 5 KN to 6 KN.
- Welding speed is 1.5m/min for thin sheet.
- A series of spot welds at continuous interval can be made along the length of the seam called roll spot welding.

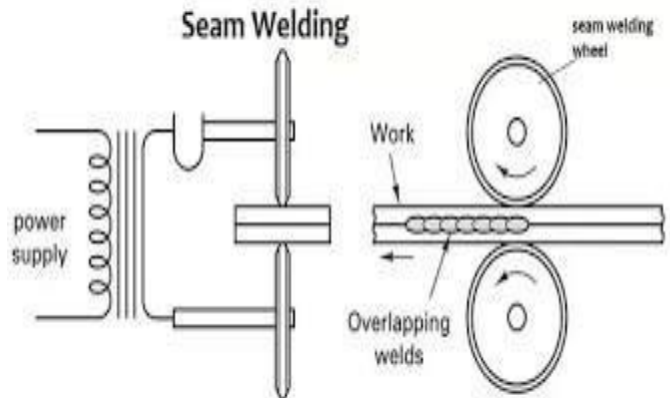
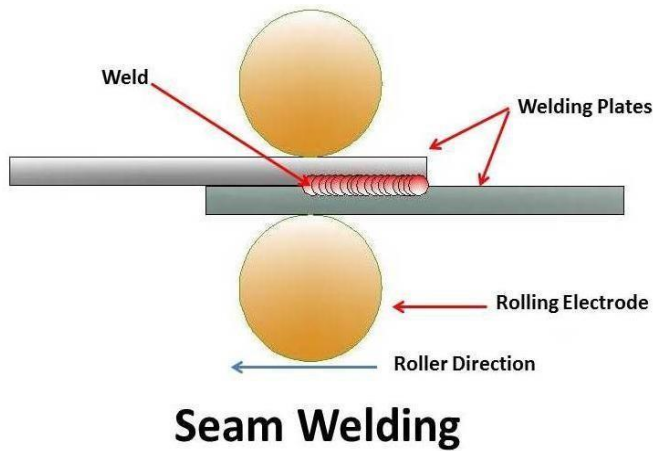

TYPES OF FLAMES

It is an established fact that the properties and nature of the gas flame have the maximum effect on oxy-acetylene welding. Proper adjustment of the flame leads to successful and efficient welding. This adjustment can be made both in regard to the characteristics and the power of the flame by regulating the pressures of oxygen and acetylene. A flame in which only acetylene burns is yellow in colour and is of no commercial use, because of its incapability to develop high temperature. The three kinds of oxy-acetylene flames, which are used in engineering works, are as follows:

1. Oxidising flame
2. Neutral flame
3. Carburising flame



1. Oxidising flame:

When supply of oxygen is more than the supply of Acetylene, this type of flame is obtained. The ratio of O_2 and C_2H_2 is 1.15 to 1.5.

This flame has a sharp inner cone which is white in colour and an outer envelope. Maximum temperature is available at the pointed tip of the inner cone.

The outer envelope acts as a covering for the molten pool during welding and prevents oxidation of surface.

Application: welding of copper, bronze, brass, zinc.

2. Neutral flame:

When supply of oxygen is equal to the supply of acetylene, this type of flame is obtained.

Here

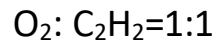

Application: Welding of stainless steel, low carbon steel, cast iron and aluminum.

3. Carburising flame:

When supply of oxygen is less than the supply of acetylene, this type of flame is obtained.

Here

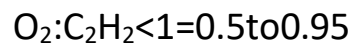

It is known as the reducing flame. Here along with the cone or inner tip and outer envelope another layer exists. This layer lies in between the cones outer envelope. This stage is known as brush or feather.

The temperature attained by these flames vary from 3100°C to 3500°C .

Application: welding of high carbon steel and Ni alloys.

CHEMISTRY OF COMBUSTION IN OXY-ACETYLENE WELDING:

The combustion of gases takes place in two or three stages in these flames. Different types of flames, together with the different terms used in connection with them. The cone or inner tip is the sharp white portion of the flame which extends just next to the tip of the nozzle. The maximum

temperature is available at the pointed tip or end of this cone. The second stage or the so called brush , or feather, is next to the cone and normally occurs in carburizing flame only. The outer envelop is relatively much larger than the other two described above and it acts as a covering for the molten pool during welding in order to prevent it from being oxidized.

The chemical action that takes place in the flame is that the combustion of gases in the first stage gives hydrogen and carbon monoxide. These products, on receiving oxygen from the atmosphere, burn further to give carbon di-oxide and water vapour or steam which forms the outer envelope.

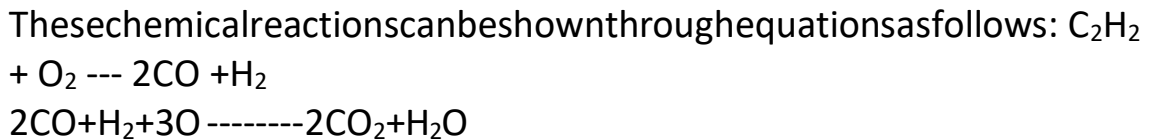

The flame can be adjusted to have desired atmosphere. The formation of inner cone is the result of increasing oxygen pressure . an oxidizing flame can be attained by increasing the supply of oxygen (i.e having excess of oxygen than acetylene). Such a flame is normally not required except in case of brass. If equal quantities of oxygen and acetylene are mixed they produce a neutral flame having a well defined white cone. This type of flame has the maximum use and a good many metals can be welded successfully by this flame. A carburizing flame is one in which the supply of acetylene is in excess as compared to oxygen. The temperature attained by these flame vary from 3100°C to 3500°C and the most commonly used temperature is about 3200°C which can be attained without any appreciable amount of difficulty.

Types of flames required for different metals:

Sl.No	Metal	Flame
1.	Brass	Oxidizing
2.	Cast iron	Neutral
3.	Mild steel	Neutral
4.	Stainless steel	Neutral
5.	Copper	Neutral
6.	Aluminum	Neutral
7.	Nickel	Neutral
8.	Monel metal	Neutral

TIGANDMIGWELDINGPROCESS

Tungsteninertgaswelding

- In this welding process the arc is struck between a non-consumable tungsten electrode and the base metal.
- The electrode is held in a special type of electrode holder which is so designed that apart from holding the electrode it also carries a passage around the electrode for flow of inert gas to provide the protective shield around the arc.
- This gaseous shield protects the electrode, molten metal, the arc and adjacent heated areas of base metal from atmospheric contamination.
- The electrode holder also carries a provision for water cooling or air cooling.

TIG Welding →

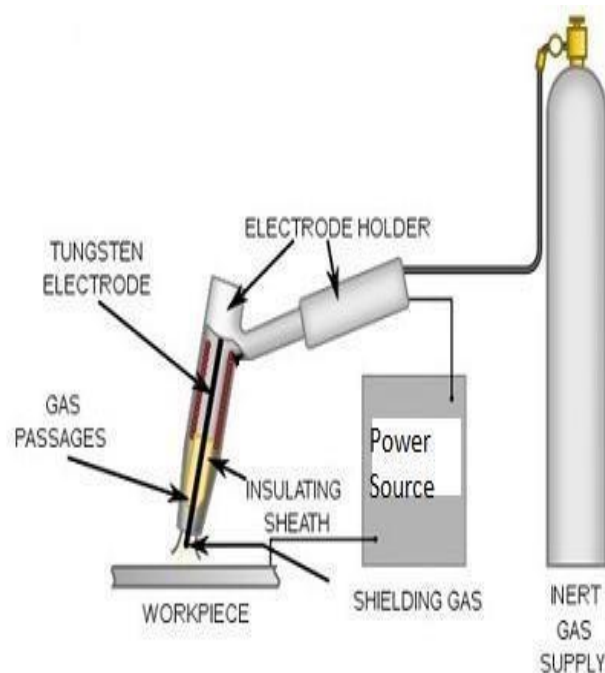

ADVANTAGES:

- TIG welds are stronger, more ductile and more corrosion resistance than welds made with ordinary shield arc welding.
- Since no flux is used it is possible to use a wide variety of design joint than conventional shield.
- There is a little weld metal splatter that damages the surface of the base metal in traditional welding.

APPLICATION

- Widely used in aerospace industry.
- Used for welding aluminum, magnesium alloys, stainless steel, nickel alloys, copper alloys.
- It can also be used for combining dissimilar metals.

Metal inert gas welding

- In this process the power source (D.C. power) connected to bare metal wire electrode and the workpieces.
- The wire electrode is connected to positive pole of power source.
- The torch is used in this process where the wire electrode fed from a spool through the torch (welding gun) at a constant speed and the torch is also connected to the hose pipe carrying shielding gas.
- Usually argon is used as shielding gas and some time mixture of Argon and Oxygen, Helium Argon and Carbon Dioxide or Argon and Carbon Dioxide are used as shielding gas.

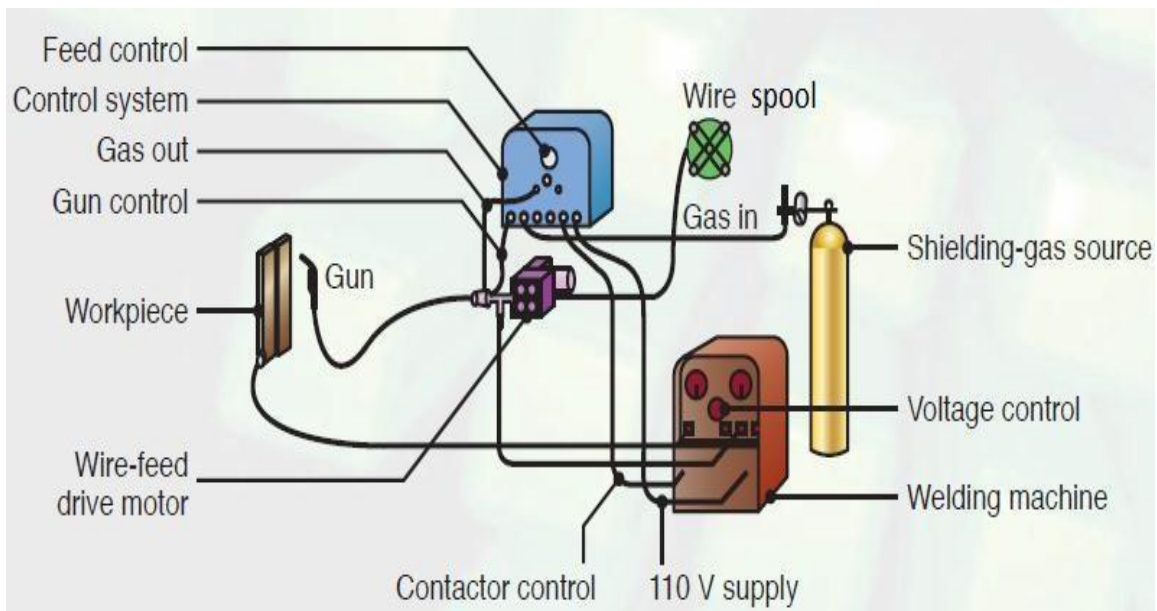

ADVANTAGES:

- It is faster than shielded metal-arc welding due to continuous feeding of filler metal.
- There is no slag formation.
- It provides higher deposition rate.
- The weld metal carries low hydrogen content.
- Deeper penetration is possible.
- More suitable for welding of thin sheets.
- Welds produced are of better quality.

DISADVANTAGES

- Equipment used is costlier and less portable.
- It is less adaptable for welding in difficult to reach portions.

- It is less suitable for outdoor work because strong wind may blow away the gas shield.

MOST COMMON WELDING DEFECTS

- Any discontinuity (or irregularity) in the weld metal, which exceeds the specified code limit, is termed as welding defects.
- Due to use of incorrect welding process or wrong welding techniques, welding defects occur.
- 7 types of most common welding defects are:
 1. Weld crack
 2. Porosity
 3. Undercut
 4. Incomplete fusion
 5. Incomplete penetration
 6. Slag inclusion
 7. Spatter

CRACKS

Cracks are the most common defects. They occur anywhere on the surface of the weld material especially on areas that are affected by direct heat.

Cracks may be formed due to various causes. They are

- Wrong joint design
- Use of hydrogen gas as a shield gas while welding ferrous metals.
- High content of carbon and sulfur in the base metal.
- High welding current.
- Rapid cooling of the weld joint.
- Inadequate preheating.
- Unequal physical property of the parent weld metals.
- Faulty welding.

These are of three types

a. Hot cracks

- The weld metal cracks are called hot cracks because these appear as a result of stress and lack of ductility of the deposited metal at high temp. These cracks occur during the welding process or during the crystallization process of the weld joint.

b. Cold cracks

- These cracks are formed near the weld area and due to excessive cooling rate and the absorbed hydrogen. Since these appear after a long time of completion of the welding operation, when the material is cold, these are termed as cold cracks. They constitute a great danger in the low alloy and high carbon steel welds.

c. Crater cracks

- These occur at the end of the welding process due to insufficient molten metal to overcome shrinkage of the weld metal when the weld pool cools and solidifies.

REMEDIES OF CRACKS

- Preheat the metal as required.
- Provide proper cooling of the weld area.
- Use proper joint design.
- Remove impurities.
- Use appropriate metal.
- Make sure to weld a sufficient sectional area.
- Use proper welding speed and amperage current.
- To prevent crater cracks, make sure that the crater is properly filled.

POROSITY & BLOW HOLES

- Porosity is a cavity like discontinuity. Porosity is basically a small pore whereas blow holes are comparatively larger holes.

- Porosity occurs as a result of weld metal contamination. The trapped gases create a bubble-filled weld or porosity in the weld as a result of which the weld joint becomes weak.

CAUSES OF POROSITY

- Inadequate electrode deoxidant.
- Using a long arc.
- The presence of moisture.
- Improper gas shield.
- Incorrect surface treatment.
- Use of too high gas flow.
- Contaminated surface.
- Presence of rust, paint, grease or oil.

REMEDIES OF POROSITY

- Clean the materials before you begin welding.
- Use dry electrodes and materials.
- Use correct arc distance.
- Check the gas flow meter and make sure that it's optimized with pressure and flow settings.
- Reduce arc travel speed, which will allow the gases to escape.
- Use the right electrodes.
- Use a proper weld technique.

UNDERCUT

- This welding imperfection is the groove formation at the weld toe, reducing the cross-sectional thickness of the base metal. The result is a weak weld joint and workpiece.

CAUSES OF UNDERCUT

- Too high weld current.
- Too fast weld speed.
- The use of an incorrect angle, which will direct more heat to free edges.

- The electrode is too large.
- Incorrect usage of gas shielding.
- Incorrect filler metal.
- Poor weld technique.

REMEDIES OF UNDERCUT

- Use proper electrode angle, with more heat directed towards thicker components.
- Reduce the arc length.
- Reduce the electrode's travel speed, but it also shouldn't be too slow.
- Choose shielding gas with the correct composition for the material type to be welded.
- Use of proper current, reducing it when approaching thinner areas and free edges.
- Use the multipass technique.

INCOMPLETE FUSION

- This type of welding defect occurs when there's a lack of proper fusion between the base metal and the weld metal. It can also appear between adjoining weld beads. This creates a gap in the joint that is not filled with molten metal.
- Lack of fusion is also called as cold lapping or cold shuts.

CAUSES OF INCOMPLETE FUSION

- Low heat input.
- Surface contamination.
- Electrode angle is incorrect.
- The electrode diameter is incorrect for the material.
- Travel speed is too fast.
- The weld pool is too large and it runs ahead of the arc.

REMEDIES OF INCOMPLETE FUSION

- Use a sufficiently high welding current with the appropriate arc voltage.

- Before beginning of welding, clean the metal.
- Avoid molten pool from flooding the arc.
- Use correct electrode diameter and angle.
- Reduce deposition rate.

INCOMPLETE PENETRATION

- Incomplete penetration occurs when the groove of the metal is not filled completely, meaning the weld metal doesn't fully extend through the joint thickness.

CAUSES OF INCOMPLETE PENETRATION

- There was too much space between the metal to be welded.
- Bead formation rate is too high, which doesn't allow enough metal to be deposited in the joint.
- Use of too low amperage setting, which results in the current not being strong enough to properly melt the metal.
- Large electrode diameter.
- Misalignment.
- Improper joint.

REMEDIES OF INCOMPLETE PENETRATION

- Use proper joint geometry.
- Use a properly sized electrode.
- Reduce arc travel speed.
- Choose proper welding current.
- Check for proper alignment.

SLAG INCLUSION

- Slag inclusion is one of the welding defects that are usually easily visible in the weld.
- Such inclusions are mostly formed by Sulphur and phosphorus.

CAUSES OF SLAG INCLUSION

- Improper cleaning.
- The weld speed is too fast.
- Not cleaning the weld pass before starting a new one.
- Incorrect welding angle.
- The weld pool cools down too fast.
- Welding current is too low.

REMEDIES OF SLAG INCLUSION

- Increase current density.
- Reduce rapid cooling.
- Adjust the electrode angle.
- Remove any slag from the previous bead.
- Adjust the welding speed.

SPATTER

Spatter occurs when small particles from the weld attach themselves to the surrounding surface. It's an especially common occurrence in gas metal arc welding.

CAUSES OF SPATTER

- The running amperage is too high.
- Voltage setting is too low.
- The work angle of the electrode is too steep.
- The surface is contaminated.
- The arc is too long.
- Incorrect polarity.
- Erratic wire feeding.

REMEDIES OF SPATTER

- Clean surfaces prior to welding.
- Reduce the arc length.
- Adjust the weld current.

- Increase the electrode angle.
- Use proper polarity.
- Make sure you don't have any feeding issues.

CASTING

- **Casting** is a manufacturing process in which a liquid material is usually poured into a mold, which contains a hollow cavity of the desired shape, and then allowed to solidify. The solidified part is also known as a *casting*, which is ejected or broken out of the mold to complete the process.
- Casting materials are usually metal or epoxy, concrete, plaster and clay.
- Casting is most often used for making complex shapes that would be otherwise difficult or uneconomical to make by other methods.
- Heavy equipment like machine tool beds, ships' propellers, etc. can be cast easily in the required size, rather than fabricating by joining several small pieces.

VARIOUS TYPES OF CASTING PROCESSES

- Sand Casting
- Investment Casting
- Plaster Casting
- Die Casting (Metal Casting Process)
- Centrifugal Casting
- Permanent Mold Casting

STEPS IN MAKING SAND CASTING

1. Patternmaking
2. Coremaking

3. Molding
4. Melting and pouring
5. Cleaning
6. Inspection

PATTERNMAKING:

The pattern is a replica of the casting used to make the mold. Considerations to be taken during pattern making are :

1. Provision of additional allowance to compensate for metal shrinkage and for machining or finishing operation of the casting.
2. Provision of draft for easy removal of the casting from the mold.
3. Provision of additional projections known as core prints to produce seats for cores.

COREMAKING:

- Cores are usually made up of sand which are placed into a mold cavity to form a cavity of desired shape and size in a casting.
- Cores are prepared usually from green sand using core boxes.
- Some times for using in permanent mold or dies cores are formed as integral parts of the mold.

MOLDING:

- It consists of all operations necessary to prepare a mold for receiving the molten metal. It includes ramming, withdrawing the pattern, setting the cores in the mold cavity, finishing and closing the mold.

- The pattern is kept in a mold box which consist of two parts , the cope and the drag. If molding board is to be used, it is first placed on the floor followed by the pattern.
- The pattern is surrounded by moldings and only in the drag part of the flask. Then the sand is compacted by ramming .Excess sand is parted off by the strike off bar and the box turned over. The other half the pattern is placed in position, followed by the cope; runner and riser are placed in position and the box filled with sand and rammed properly. Runner and riser are taken out and the pouring basin is made. Vent-wire is then applied to provide the vents.
- After the sand is compacted enough to replicate the pattern, the cope is removed and the pattern is extracted. Repairs if any , are made and the gates cut. Then, any additional inserts called core boxes are installed. Now the mold is ready for pouring.

MELTING AND POURING:

- The raw material is melted using a furnace and the molten metal is poured into the mold using ladle.

CLEANING:

- After proper solidification of casting the molds are broken to obtain the casting. This operation is called shake out operation. This casting carries risers , runners, gates, chills, and nails etc. attached to it. Also a lot of sands remain adhering to its surface in the form of core, etc. Removal of sands, excess metals in form of fins, risers, runners, gates, chills, and nails is done for cleaning the casting.

REPAIRANDHEATTREATMENTOFCASTING:

- Before use the required repairing is done and by heat treatment process , the required structure and mechanical properties of the casting is obtained.

INSPECTION:

- Inspection of the casting to detect internal and external defects and general quality is done.

SANDMOLDCASTING

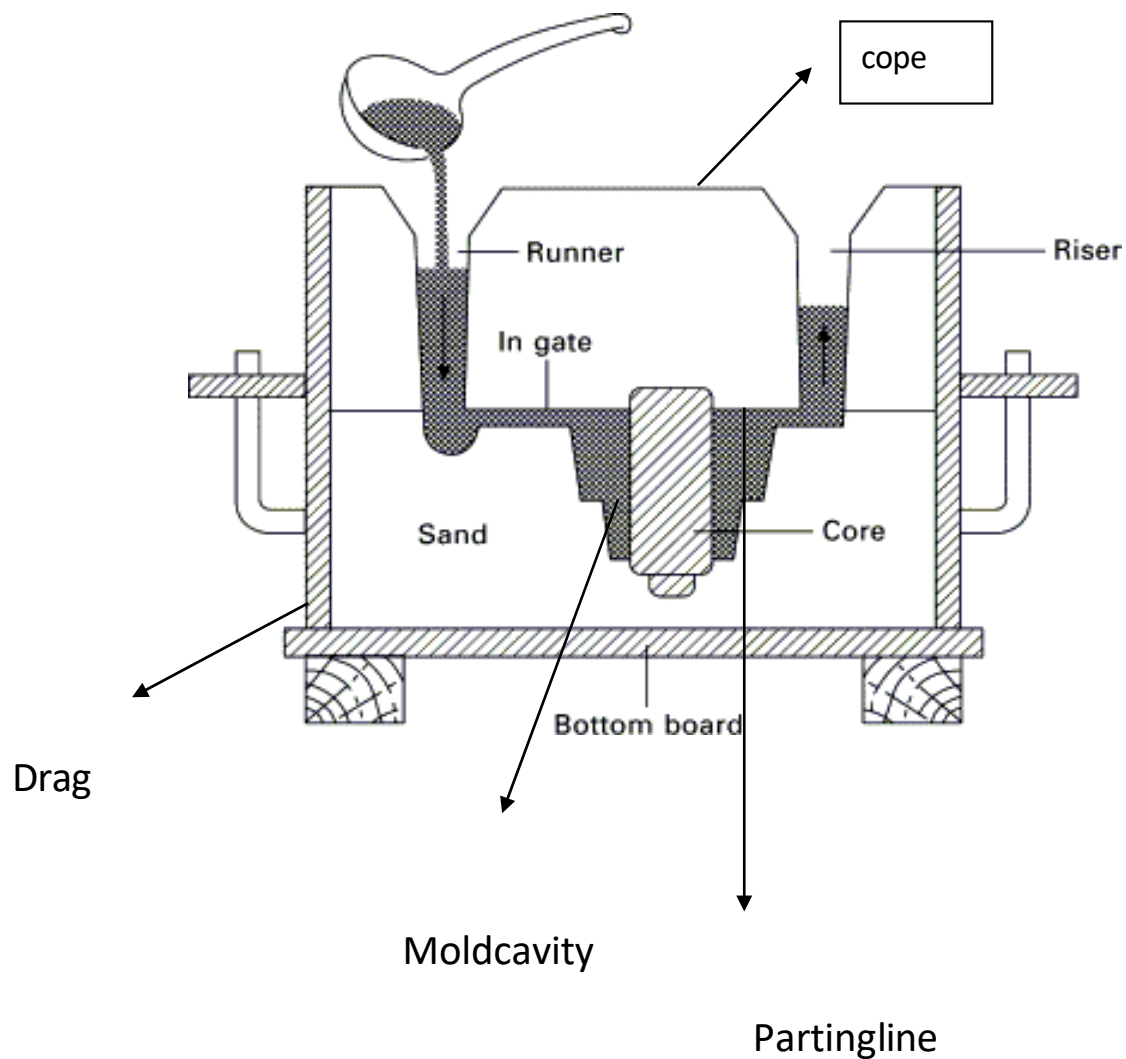

ADVANTAGES OF SAND MOLD CASTING

- Relatively low cost of production.
- Large components can be fabricated.
- Both ferrous and nonferrous materials can be casted.

DISADVANTAGES OF SAND MOLD CASTING

- Lower degree of accuracy
- Rough surface finish.

DIFFERENT TYPES OF MOLDING SAND

Molding sand can be classified mainly into two types. They are :

1. Natural molding sand
2. Synthetic molding sand

NATURAL MOLDING SAND

- Natural molding sands consist of refractory sand grains associated with clay right from their origin.
- It contains sufficient amount of binder material.

SYNTHETIC MOLDING SANDS

- Synthetic molding sands are prepared artificially using basic sand molding constituents (silica sand in 85-91%, binder 6-11%, water or moisture content 2-8%) and other additives in proper proportion by weight .
- Molding sands can also be classified into **various types according to their use** .

- These are backing sand, core sand, dry sand, facing sand, green sand, loam sand, parting sand, system sand.

GREENSAND

- **Green sand** is known as **tempered or natural sand** . This is a prepared mixture of silica sand with 18 to 30% clay, having moisture content from 6 to 8%. The clay and water furnish the bond for green sand. Green sand is commonly employed for production of small and medium casting of non-ferrous metals and alloys.

DRYSAND

- Green sand that has been dried or baked in suitable oven after making mold and cores is called **dry sand**. It possesses more strength, rigidity and thermal stability. Dry sand is mainly used for larger castings and for small casting which need higher accuracy. Molds prepared in this sand are known as dry sand molds.

LOAMSAND

- **Loam sand** is mixture of sand, clay and water and made into a thin plastic paste. Loam sand possesses high clay as much as 30-50% and 18% of water. Patterns are not used for loam molding and shape is given to mold by sweeps.
- After preparing the mold, it is baked to give strength to resist the flow of the molten metal.
- Loam sand is particularly employed for loam molding used for large grey iron castings.

BACKINGSAND OR FLOOR SAND

- Backing sand is used to fill the whole volume of the molding flask. Backing sand is also called black sand because of old, repeatedly used molding sand is black in color due to addition of coal dust.

CORESAND

- **Core sand** is used for making cores. It is known as oil sand. Core sand is highly rich in silica sand mixed with oil binders such as linseed oil, resin, light mineral oil and other bind materials.

FACINGSAND

- **Facingsand** forms the face of the mould. It is next to the surface of the pattern and it comes into contact with molten metal when the metal is poured. Facingsand is made of silica sand and clay, without the use of already used sand.

PARTINGSAND

- **Parting sand** is clean clay-free silica sand. It is used in parting line or parting surface of the cope & drag.

SYSTEMSAND

- In mechanized foundries where machine molding is employed, System sand is used to fill the whole molding flask. The used sand is cleaned and re-activated by the addition of water and special additives. Since the whole mold is made up of this system sand, the properties such as strength, permeability and refractoriness of the molding sand must be higher than those of backing sand.

BASIC PROPERTIES OF MOLDING SAND

1. Flowability or Plasticity:

- It is a property of the molding sand to flow and get compacted all-round the pattern when rammed and take up the required shape.

2. Refractoriness:

- It is the ability of the molding sand to withstand the high temp. of the liquid metal to be poured, without breaking down or fusing.
- The refractoriness of silica sand is highest.

3. Permeability :

- It is the ability of the molding sand to allow air and any hot gases to pass through it even in compacted condition.

4. Green strength:

- The molding sand that contains moisture is termed as green sand. Green strength is the ability of green sand to retain the shape of the constructed mold.

5. Dry strength:

- It is the ability of molding sand to retain the exact shape of the mold cavity in the dry condition (when the molten metal is poured in the mold) and to withstand the metal static pressure of the liquid metal.
- The Dry strength prevents the enlargement of mold cavity.

6. Hot strength:

- It is the ability of the molding sand to retain the exact shape of the mold cavity at an elevated temp.

7. Adhesiveness:

- It is the ability of the moldings sand to stick with the wall of the molding boxes.

8. Cohesiveness:

Cohesiveness is the property of molding sand by virtue of which the sand grain attract each other within the molding box.

9. Collapsibility:

- Collapsibility is the property by virtue of which molding sand is easily stripped off the casting after the molten metal in the mold gets solidified.
- The lack of collapsibility results tears and cracks in the casting.

MISCELLANEOUS PROPERTIES OF MOLDING SAND

- In addition to basic properties, the molding sand should not stick to the casting and should not chemically react with the metal. Molding sand need be economically cheap and easily available in nature. It need be reusable for economic reasons.

PATTERN

- It is the replica of the final object to be made.
- The mold cavity is made with the help of pattern.
- In other words to create the cavity in the compacted sand we need a model, so this model is known as pattern.

FUNCTION OF PATTERN

1. It prepares the mold cavity.
2. It enables certain core prints at both ends of the pattern.
3. It makes provision for runner, gate and riser.
4. Properly made patterns having smooth surface, reduce casting defects.
5. A properly constructed pattern minimizes the overall cost of the casting.

PATTERN MATERIALS

1. Wood, metals and alloys, plastic, plaster of Paris, rubbers, wax, and resins are used for pattern making. Each material has its own advantages, limitations and field of application.

IDEAL CHARACTERISTIC OF PATTERN MATERIAL

- Light in weight.
- Strong, hard and durable.
- Resistant to wear and abrasion.
- Resistant to corrosion and chemical reaction.

- Dimensionally stable and unaffected by variation of temperature and humidity .
- Available in low cost.

CLASSIFICATION OF PATTERN

The use of a pattern for a particular casting depends upon many factors like

1. Type of molding process
2. No of casting required.
3. Design of casting

- Accordingly the patterns are classified into following types:

1. Solid or Single piece pattern
2. Two-piece or split pattern
3. Multi piece pattern
4. Cope and drag pattern
5. Match plate pattern
6. Follow board pattern
7. Gated pattern
8. Sweep pattern
9. Pattern with loose pieces
10. Skeleton pattern
11. Segmental pattern

TYPES OF PATTERN

1. SINGLE PIECE PATTERN:

These are inexpensive and the simplest, as a name indicates they are made up of a single piece. This type of pattern is used only in cases where the job is very simple and does not create any problems. This pattern is expected to be entirely in the drag part of the mold box.

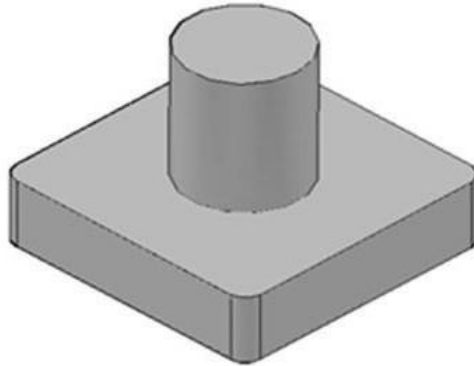

One Piece or Solid Pattern

2. SPLIT OR TWO-PIECE PATTERN

This is the most widely used type of pattern for intricate casting, when withdrawal of the casting from the mold is difficult due to its shape. The pattern is split into two parts and they are joined at the parting line by means of dowels. While molding one part is contained by the drag and the other one is contained by the cope. The split surface of the pattern is the same as the parting plane of the mold.

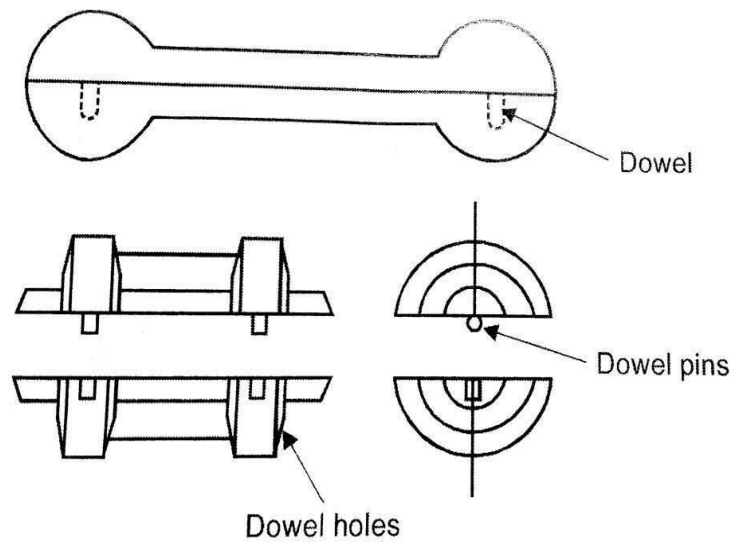

3. MULTIPIECEPATTERN

This pattern is used for casting of complicated parts . These pattern may consist of three ,four or more numbers of parts. Use of this pattern facilitated easy withdrawal of pattern during mold preparation.

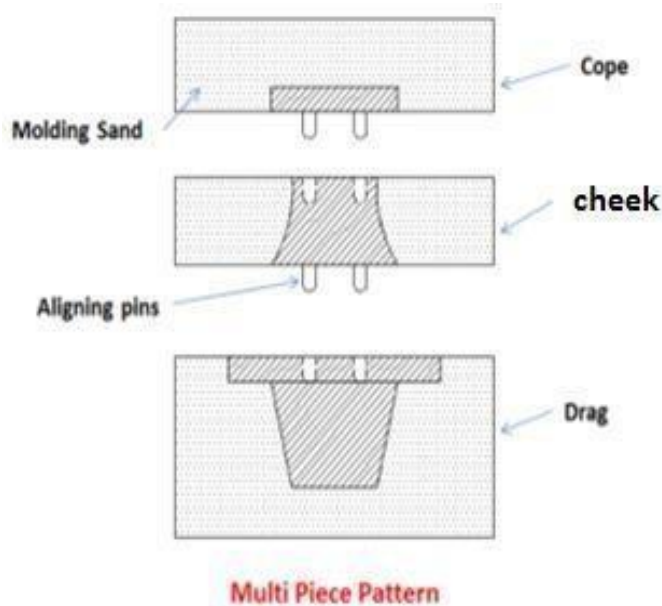

4. COPEANDDRAGPATTERN

- This is similar to split pattern. The cope and drag halves of the pattern along with the gating and riser are attached separately to the metal or wooden plates. The cope and drag molds may be produced using this pattern separately by the molder but they can be assembled to form a complete mold. This type of pattern is used for casting which are heavy.
- This is used for big casting.

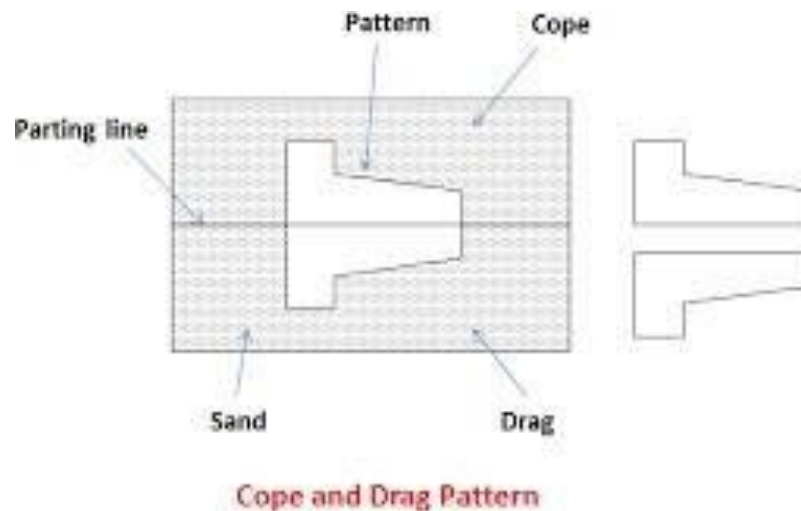

5. MATCHPLATEPATTERN

- These are extensions of cope and drag pattern. Here the cope and drag patterns along with the gating system and riser system are mounted on either side of the match plate, made up of metal or wood. On one side of the match plate the cope part of the pattern is mounted and on the other side of the match plate the drag part is mounted. After molding when match plate is removed a

complete mold with gating system is obtained by joining the cope and the drag together.

- The complete pattern is made up of metal, usually aluminum for its light weight and machinability.

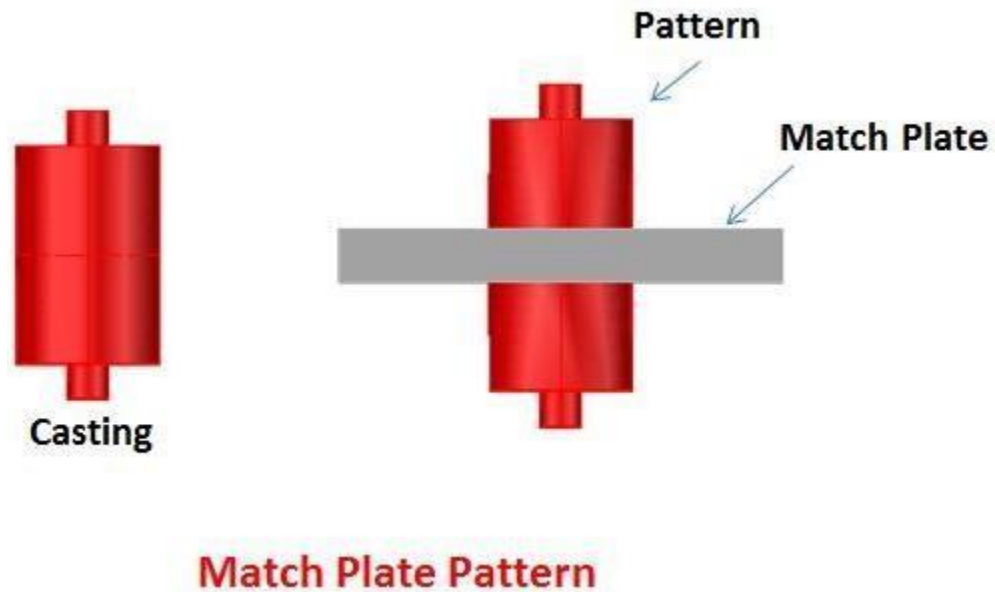

6. FOLLOWBOARDPATTERN

- A follow board is a wooden board used to act as a seat for the pattern. Patterns having an odd shape or very thin wall require a follow board. The follow board is provided with a cavity corresponding to the shape of the pattern in which the pattern is seated for molding.
- This type of pattern is adopted for those castings, where there are some portions, which are structurally weak and if not supported properly are likely to break under the force of ramming .

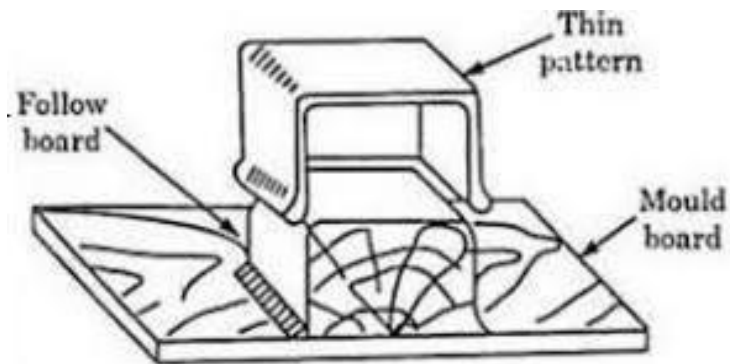

Follow-board Pattern.

7. GATED PATTERN

- This is used for mass production of small castings.
- This is an improvement over the simple pattern and are used, where gating and the runner system are integral part of the mold.
- By using this pattern multicavity molds along with gates and runner can be prepared .

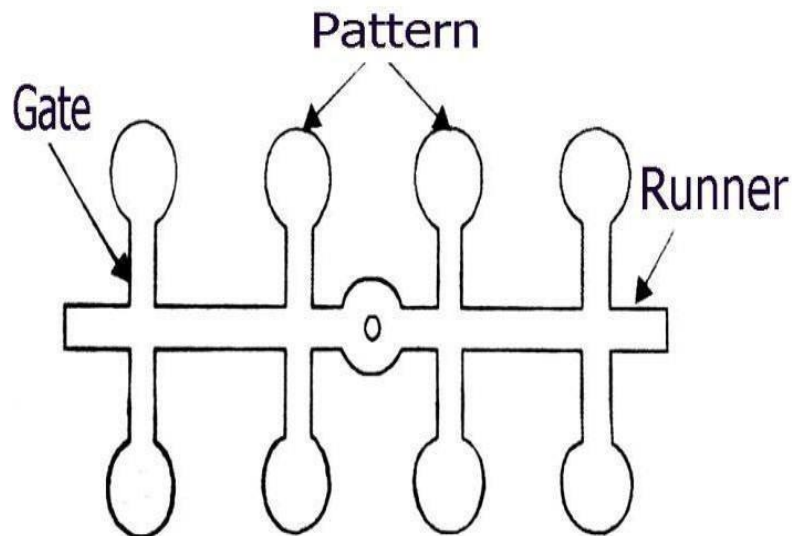

8. SWEEP PATTERN

- This pattern consists of a base , a vertical spindle and a wooden template, called sweep.
- The outer end of the sweep carries the contour corresponding to the shape of the desired casting.
- The sweep is rotated about the spindle to form the cavity. then the sweep and spindle are removed , leaving the base in the sand.
- The hole made by the removal of spindle is patched up by filing the sand.
- These are used for generating circular or prismatic shape or cylindrical shape.
- This greatly reduces the cost of a 3D pattern.
- This type of pattern is particularly suitable for very large cylindrical castings.

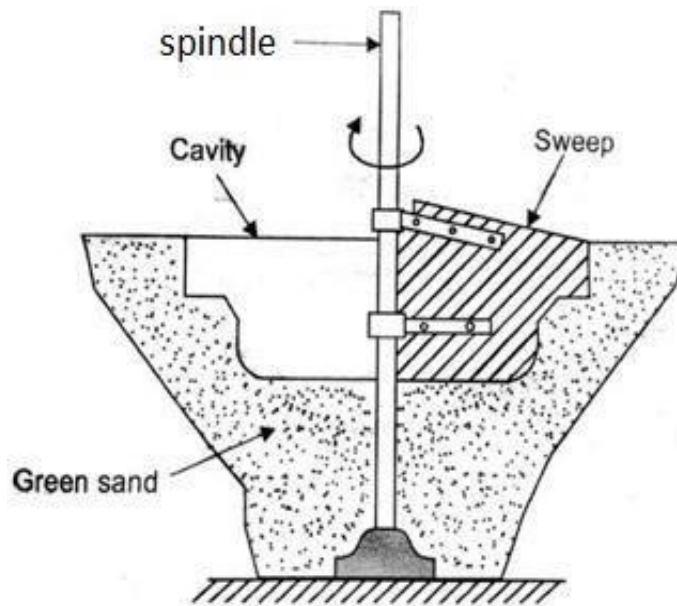

9. LOOSEPIECEPATTERN

- This type of pattern is used when the shape of the part is such that withdrawal of the pattern from the mold is not possible. Hence during molding the obstruction part of the shape is held as a loose piece by a wire.
- After molding is over first the main pattern is removed and then the loose pieces are removed through the gap generated by the main pattern.

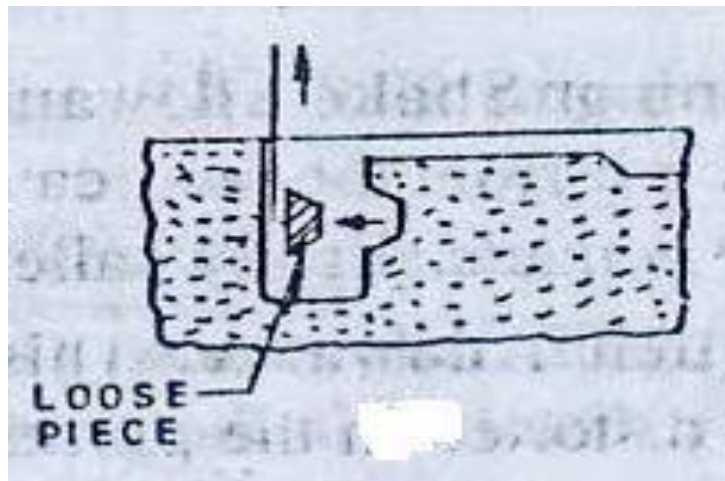

10. SKELETONPATTERN

- It is built in two parts - one for cope and other for drag.
- Skeleton pattern consists of a wooden frame and strips.
- It is filled with loam sand and the surplus sand is removed by means of a stickle.
- The type of a skeleton to be made depends on geometry of the work piece.

- This type of pattern is useful for casting turbine blades or any other castings of very large size but easy to shape and when very few numbers are to be made.

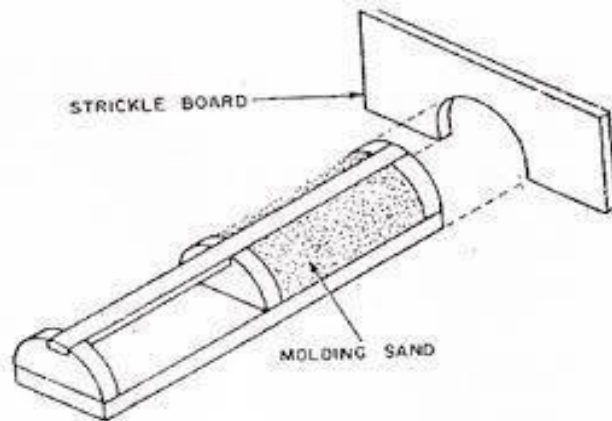

11. SEGMENTAL PATTERN

- These patterns are used for preparing molds of large circular castings. In this pattern a portion of the solid pattern (required to develop the mold shape) is mounted on a central pivot. The part mold in one position is prepared and then this segment is moved to the next position. The operation is repeated till the complete mold is ready.
- This pattern works like a sweep pattern but the difference is that a sweep is given a continuous revolving motion to generate the desired shape, where a segmental pattern prepared the mold in parts.

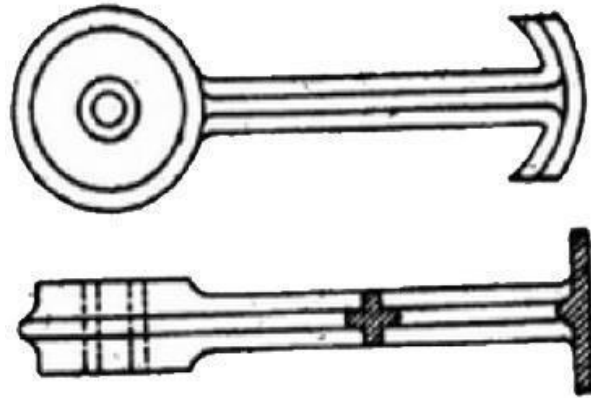

PATTERN ALLOWANCE

The pattern should be made larger as compared to the required size of the casting. The difference between the actual size and required size is known as pattern allowance.

SHRINKAGE/CONTRACTION ALLOWANCE

- Most of the metal contracts during cooling from pouring temperature to room temperature. This contraction takes place in three forms i.e. liquid contraction, solidifying contraction, and solid contraction.
- The first two are compensated by gates and risers, and the last one by providing adequate allowances in the pattern.
- The shrinkage allowance in the pattern varies with variation in casting metal.

DRAFT ALLOWANCE

- Slight taper is provided on the vertical surfaces of the pattern, so that it can be removed from the sand without damaging the sides.

of the sand mold. This taper is known as draft allowance. It can be expressed in degrees .

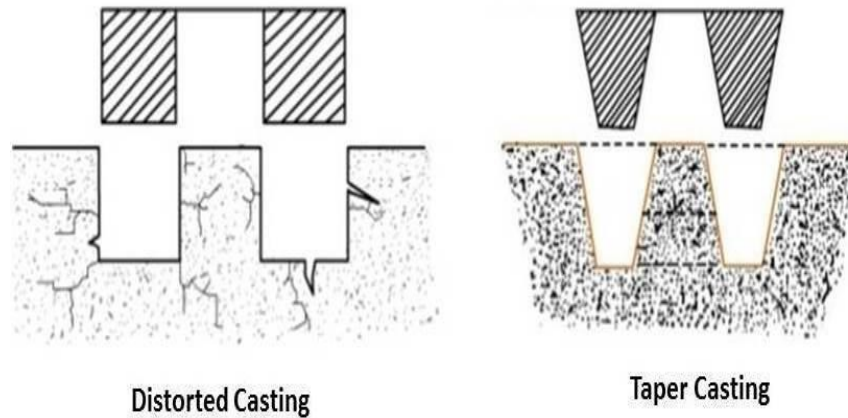

Draft Allowance

MACHINING ALLOWANCE OR FINISHING ALLOWANCE

- Pattern size should be made little bigger than the required size of the casting because after machining we will get the exactly same size of the casting.
- Ferrous metal need more allowance than the non-ferrous metal.

DISTORTION/CAMBER ALLOWANCE

Sometimes casting gets distorted during solidification due to their critical shape.

- Non uniform contraction of casting during cooling causes thermal stresses, which results discursion.

- To eliminate this defect an opposite distortion is provided in the pattern, so that the effect is neutralised and the correct casting is obtained.

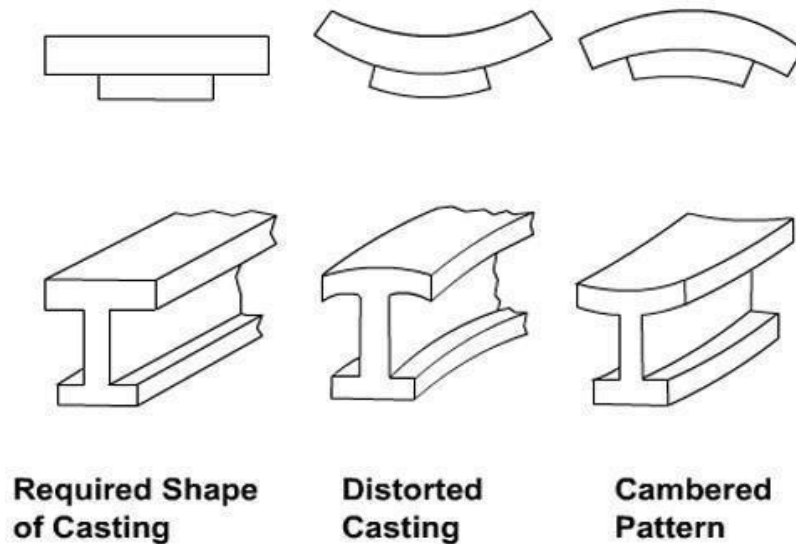

RAPPING ALLOWANCE

- Rapping means shaking the pattern from side to side , so that its surface may be free of the adjoining sand wall of the mold. By this action the volume of the mold cavity increases.
- The pattern size should be little smaller as compared to the casting size to compensate the increase of mold cavity due to rapping of the pattern.
- This negative allowance is known as rapping or shake allowance.

MOLD WALL MOVEMENT ALLOWANCE

- Movement of mold walls in sand molds takes place on account of the excessive heat and the static pressure exerted on the surface layer of sand which comes in contact with the mold metal.
- When this movement is not controlled by controlling the density and temperature of the molten metal and composition of the molding sand, allowance is provided in the pattern to compensate this difference in volume due to wall movement.

CORE

- Core comes into picture when we have to make components of hollow cavity.
- It is made up of sand.
- A core can be defined as a body of sand, which is used to form a cavity of desired shape and size in a casting.
- The cores are divided into two types basing on the method of their preparation. They are:
 1. Green sand core
 2. Dry sand core

Green Sand Core:

These are obtained by the pattern itself during molding. This is used only for those type of cavities which permit the withdrawal of the pattern, leaving the core as a part of the mold.

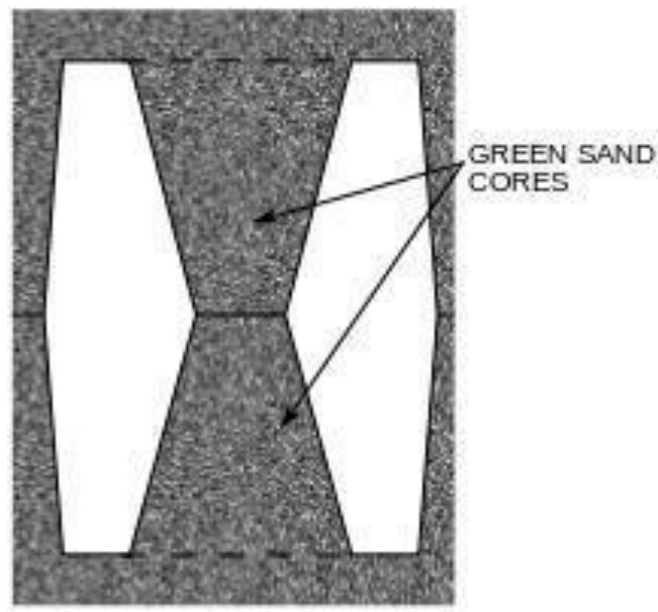

Dry Sand Core:

A core is prepared separately in core boxes and dried, is known as dry sand core. The dry sand cores are also known as **process cores**. These cores are located in the mold in the seats formed by the core prints provided on the patterns.

TYPES OF CORES

- Depending on the shapes and positions in the prepared mold, the cores are classified into following types :
- Horizontal core
- Vertical core
- Balanced core
- Hanging or cover core

- Stopoffcore
- Ramupcore
- Kiss core

Horizontalcore:

- It is the most common and simple type of core. It is assembled in the mold with its axis horizontal.

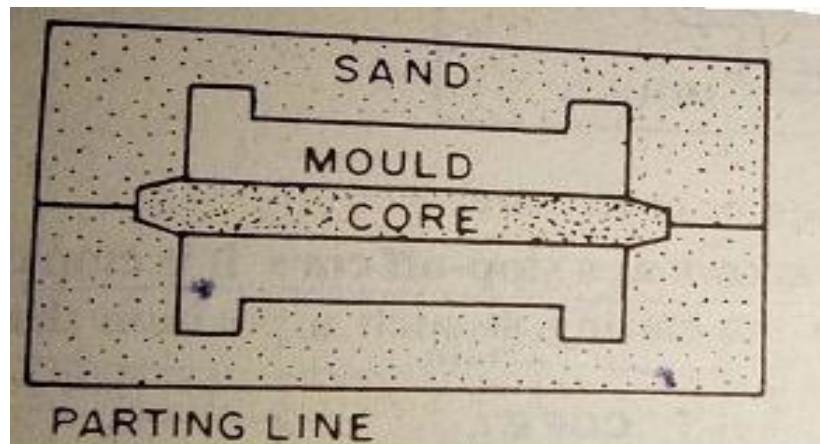

HORIZONTAL CORE

Verticalcore:

- It is quite similar to a horizontal core except that it is fitted in the mold with its axis vertical. A major portion of the core usually remains in the drag part of the mold.

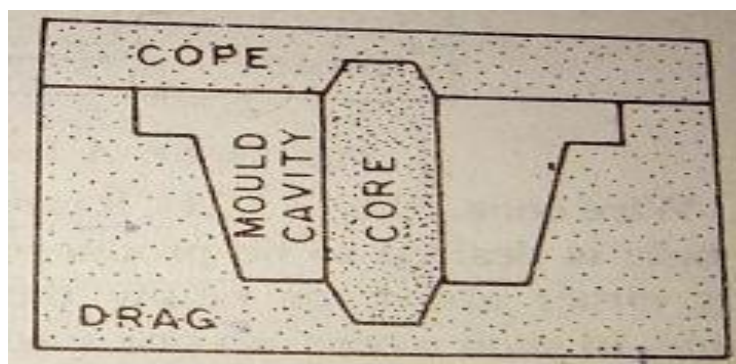

VERTICAL CORE

Balanced core:

- It is used to produce a blind hole along a horizontal axis in a casting. It is supported only on one end, the other end remaining free in the mold cavity. Since it has to support the weight of the overhanging portion, the core print provided on the pattern should be long enough so that sufficient length of the core may be embedded in the sand to balance the weight of the overhang.

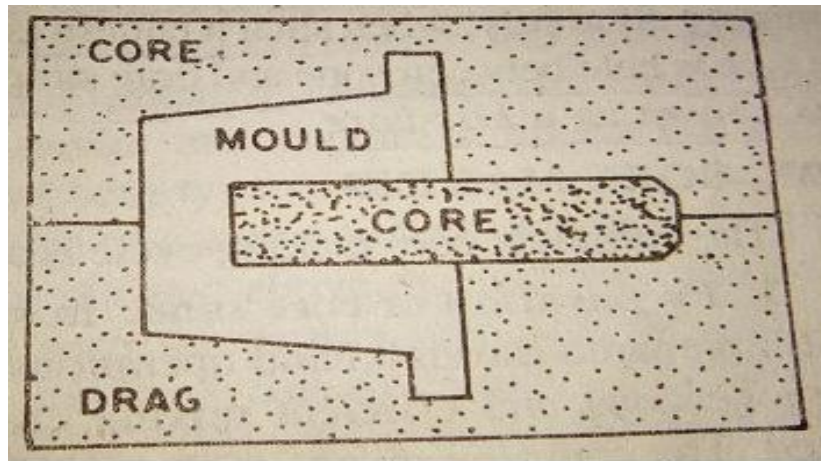

BALANCED CORE

Hanging or cover core:

- A core which hangs vertically in the mold and has no support at its bottom is known as a hanging core.

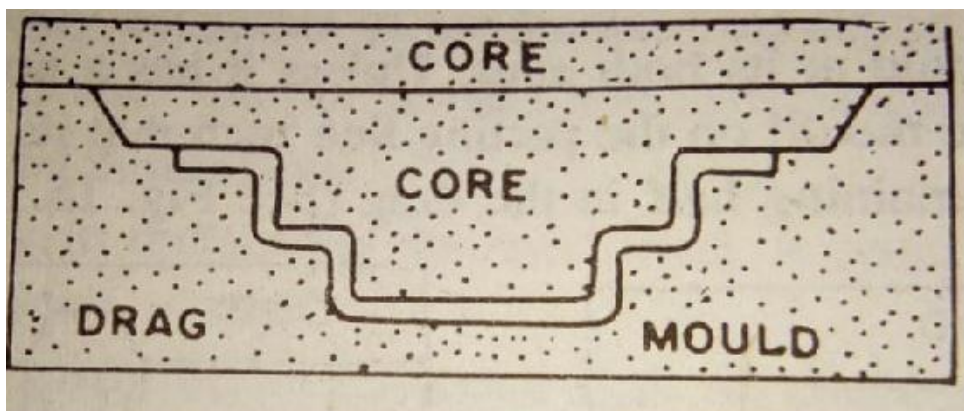

HANGING OR COVER CORE

Stop-off core:

- It is employed when a hole is desired to be produced in the casting at such a position that its axis falls either above or below the parting line.

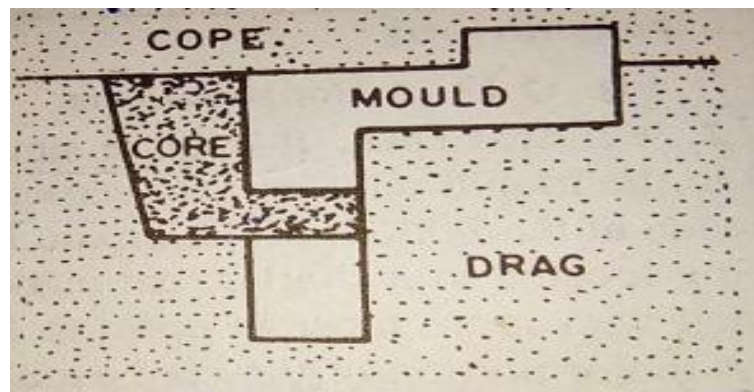

STOP-OFF CORE

Ram up core:

- Ram up core is embedded in the mold as placement of core is not possible after ramming.

Kiss core:

- Kiss core is used where a pattern is to be used without any core prints. The core is held between cope and drag simply due to the pressure put by the former.

CUPOLAFURNACE

- For melting of cast iron in foundry the cupola furnace is used. A diagrammatic sketch of this furnace is a cross sectional view of cupola.

SparkArrester

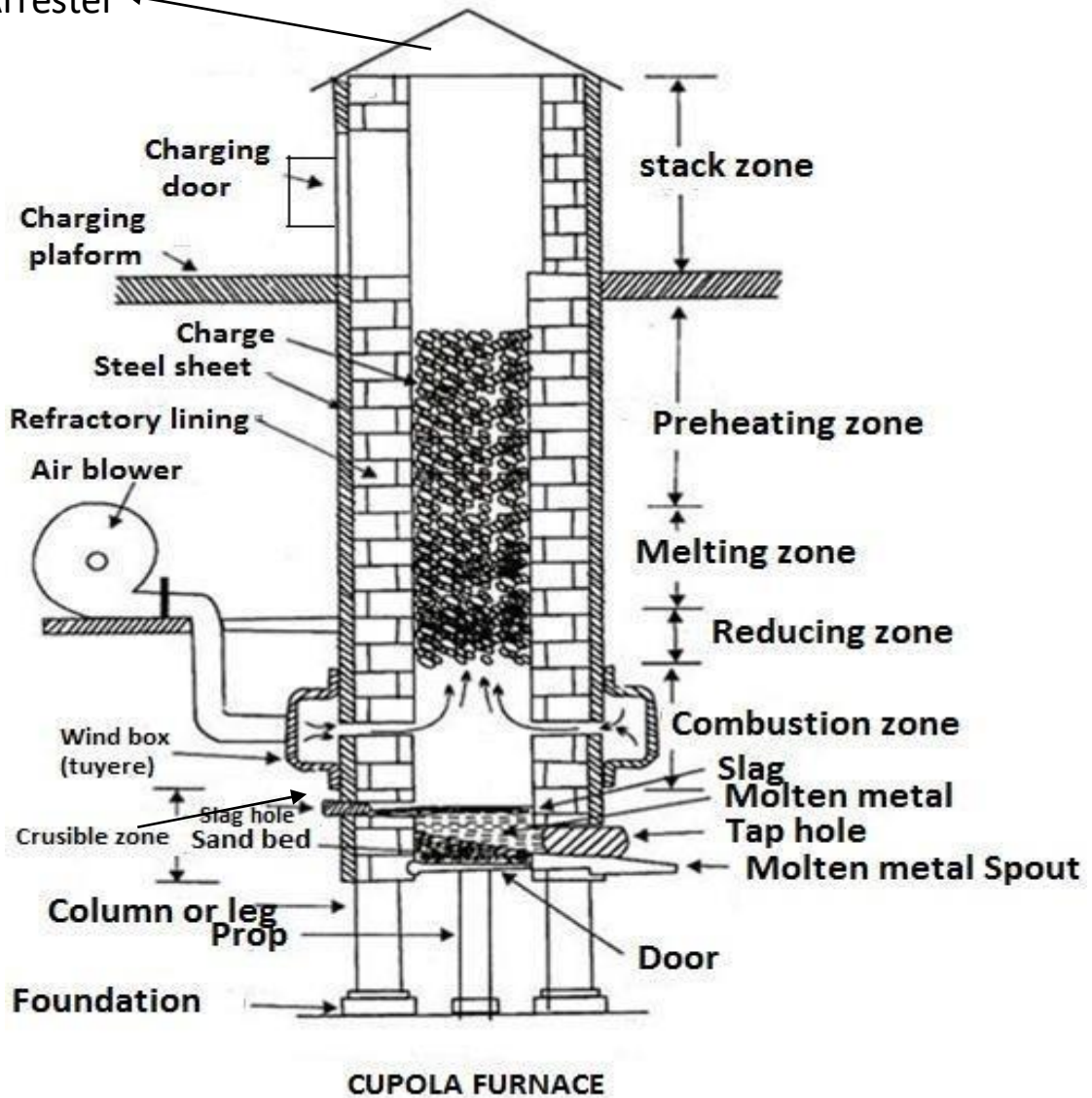

CONSTRUCTION OF CUPOLA

- The parts of cupola furnace are:
- Shell
- Foundation
- Tuyer
- Windbelt
- Blower
- Metal tapping hole
- Slag hole
- Charging door
- Chimney or stack

Shell:

- It is in the form of a hollow vertical cylinder made up of strong mild steel plates with a lining of refractory bricks and clay. The plates are riveted or welded at the seams.
- Tapered sand bed is provided at the bottom most part of shell to provide refractory bottom for the molten metal.
- The bottom door (drop door) is hinged to a supporting leg. When the cupola is in operation, the bottom door is supported by a prop.

Foundation:

- Brick wall or steel column foundation is provided to support the shell.

Tuyer:

- Tuyeres are the opening through which forced air enter into the furnace chamber from the wind chamber with the help of blowers.
- Tuyeres are provided all around the shell and have a definite numbers and size depending upon the amount of air required.

Windbelt:

- A wind chamber or a wind belt encircle the cupola shell at a place little above the bottom of the shell. This belt is connected to the furnace blower by means of a blast pipe.

Blower:

- Blower is used to ensure availability of adequate air through out the coke bed . The capacity of the blower varies directly with the size and capacity of the cupola.

Metaltappinghole:

- Metaltappinghole exists just above the sand bed.

Slaghole:

- Slag hole may be kept at a height of about 25 to 30 cm from the bottom of the cupola and located above metal tap hole. Normally it exists in a position opposite to the metal tap hole.

Chargingdoor:

- This platform is of robust mild steel construction, supported on four strong steel legs and is provided with a ladder.
- A little above charging plat form is the charging door in the shell from where the charge consists of PIG iron, scrap iron, coke and flux is put into the cupola.

Chimneyorstack:

- Chimney is provided to escape the waste gases to the atmosphere. The top of the chimney is provided with a mesh screen and a spark arrester.

WORKING OF CUPOLA FURNACE

1. To operate the cupola, first the drop doors at the bottom are closed and a sand bed with a gentle slope towards the Metal tap hole is rammed. Then a coke bed of suitable height is prepared above the bottom sand bed and ignited through the tap hole.
2. When the coke bed is properly ignited, alternate charge, flux and coke is fed into through the charge door until the level of the charging door .
3. Then the air blast is turned on and forced air comes through the tuyeres . Combustion occurs rapidly within the coke bed.
4. Within 5-10 min after the blast is turned on, molten metal is deposited near the tap hole.
5. When enough molten metal is deposited the slag is banded up to the slag whole before opening the tap hole.
6. The molten metal is collected in the ladle and then transferred to the cavity into which it is to be poured.

CRUCIBLE FURNACES

1. Crucible furnaces:

- In these furnaces the entire melting of metal takes place inside a melting pot, called crucible, which is made of clay and graphite. There is no direct contact between the flame and the metal charge . These furnaces are used for melting non ferrous metal and their alloy to produce small and medium size castings in foundries. These furnaces can be classified into two groups as follows:

a) Coke-fired furnaces

b) Oil and gas fired furnaces

CONSTRUCTION

- These furnaces are generally installed in a formed pit. They are provided with refractory lining inside and a chimney at the top. Both natural as well as artificial draughts can be used.

WORKING OF COKE FIRED CRUCIBLE FURNACES

- Broken pieces of metal are placed in the crucible. Bed coke is fired in the furnace and the crucible placed into it. Afterwards more coke is placed all around the crucible. The heat generated by burning of the coke melts the metal inside the crucible.
- These are used for melting small quantities of ferrous metals (pig iron) for producing iron casting and also for non-ferrous metals and alloys. Coke is used as fuel.

COKE-FIRED FURNACES

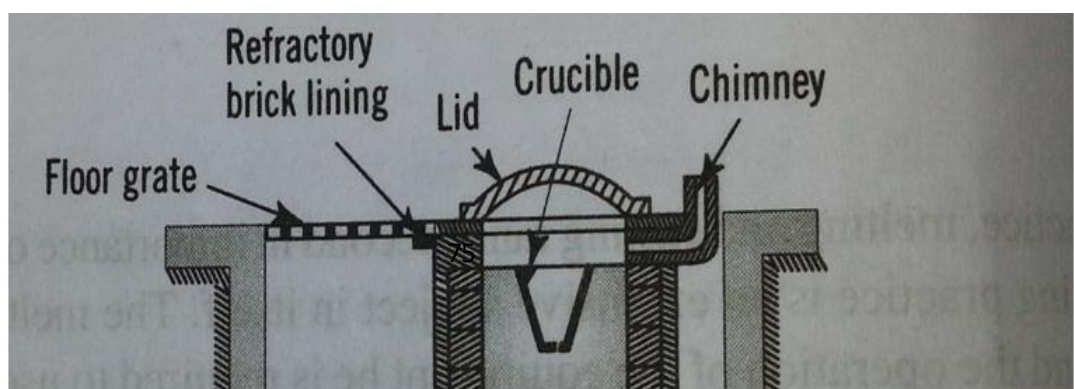

OIL OR GAS FIRED FURNACES

- These furnaces utilise oil or gas as a fuel. A mixture of gas and air or oil and air is fed into the furnace which burns inside to produce the desired temperature. The mixture usually enters tangentially and encircles the crucible while burning.
- These furnaces may be of stationary type or tilting type. The latter type are more preferred.

CONSTRUCTION OF STATIONARY TYPE GAS FIRED FURNACES

- The furnace essentially consists of a cylindrical steel shell, provided with refractory lining inside and proper passage for entry of the fuel mixture. The crucible is seated on a pad formed at the bottom. A cover is provided at the top to prevent heat losses.

STATIONARY TYPE GAS FIRED CRUCIBLE FURNACES

To atmosphere

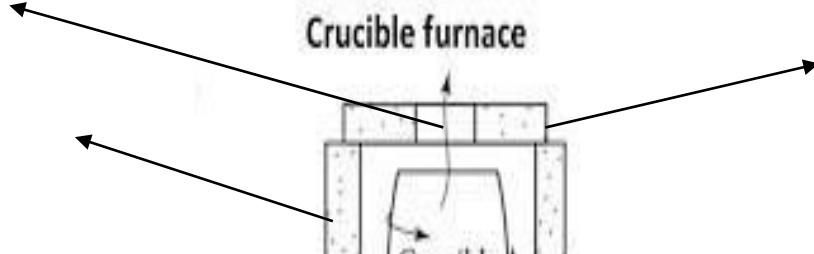

Refractory lining

pad

WORKING OF STATIONARY TYPE GAS FIRED CRUCIBLE FURNACES

- These furnaces utilise gas as a fuel. A mixture of gas and air is fed into the furnace which burns inside to produce the desired temperature. The mixture usually enters tangentially and encircles the crucible while burning. The heat generated due to burning of fuel gas rises to the temperature of the metal inside the crucible and melts the metal.

OIL FIRED TILTING CRUCIBLE FURNACES

- An oil-fired tilting furnace consists of an outer shell, having a refractory lining inside. The hollow portion around the crucible forms a chamber, through which circulates the burning fuel. The gases finally escape into the open atmosphere. Air at a definite pressure is supplied from the blower and the oil comes from the oil tank through the oil preheater. The oil tank is kept at a sufficient height and the oil is pumped into the tank.

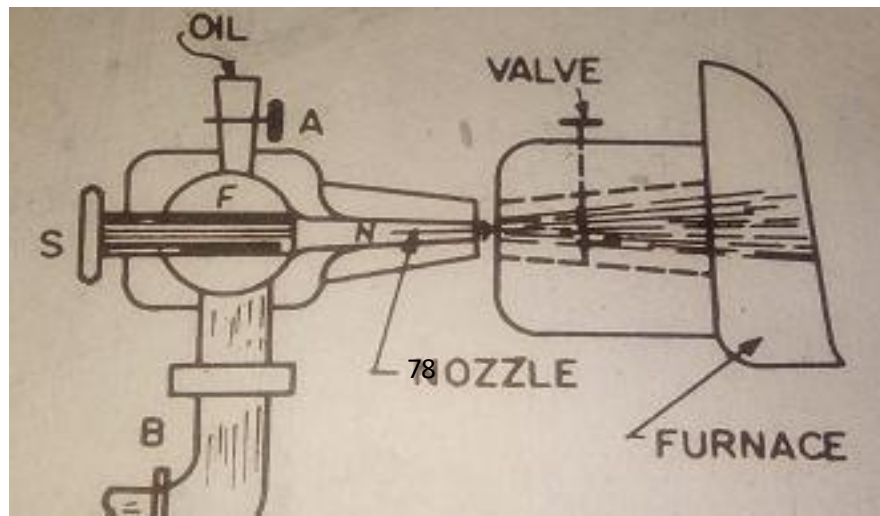
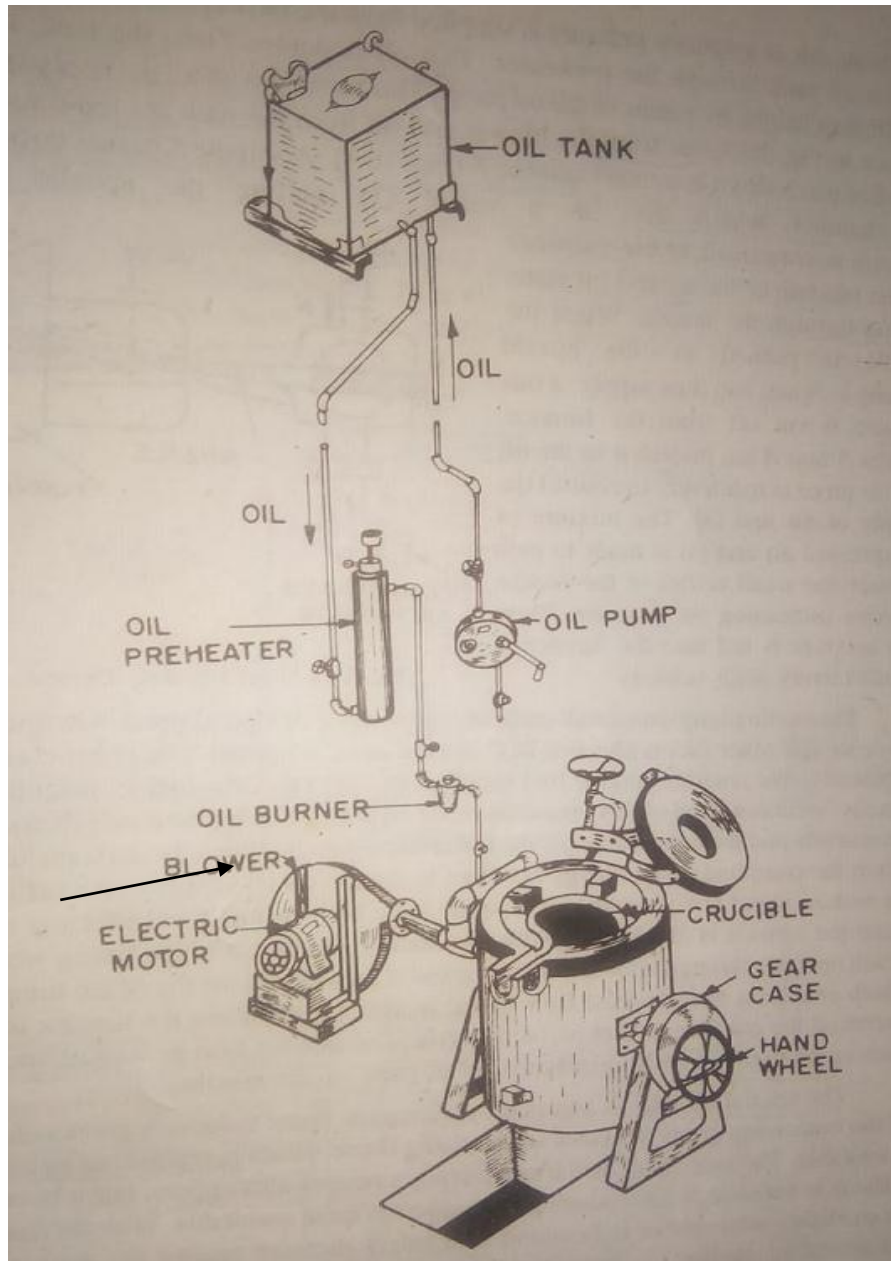

WORKING OF OIL FIRED TILTING CRUCIBLE FURNACES

- As shown in the diagram air from the blower and oil from the tank are fed through respective pipes into a common chamber F. A spindle S passes through this chamber which acts as a valve. On pulling the spindle the nozzle N is connected to the chamber and the mixture of the air and oil starts passing through the nozzle.
- For starting ignition a small piece of cotton waste or cloth dipped in kerosene oil or similar other fuel is attached at C and the same is lighted. The metal charge is placed in the crucible and the fuel supply is started. Once the fuel jet is ignited, there is no further need of this operation being repeated. The burning fuel encircles the crucible and the temperature of the metal rises, which ultimately starts melting.
- When the furnace is in operation the crucible is kept perfectly vertical so that the heat generated due to burning of fuel is evenly distributed to all parts of the crucible.
- When the spindle is pushed in the nozzle opening is closed and thus supply of this mixture is cut off from the furnace. Valves A and B are provided in the oil and air pipes respectively to control the supply of air and oil.

- When the complete metal charge has been melted the fuel supply is cut off and the molten metal is collected in a separate ladle for pouring. For collecting this metal the furnace is tilted along with the crucible, by means of the tilting wheel which operates through a set of gears. A spout is provided at the top of the furnace which enables a well directed flow of the molten metal.

DIE –CASTING

1. Die casting is a type of permanent mold casting. In this process the molten metal is forced into the permanent cavity of steel mold called a die under very high pressure. The die casting is also called pressure die casting.
2. The dies are usually made in two halves one is fixed and another is movable. The two halves must be locked perfectly during pouring and solidification of molten metal. After solidification the two halves are to be opened for ejecting the casting .
3. The die casting is suitable only for low melting point metals and alloys.

TYPES OF DIECASTING

1. Hot chamber die casting
2. Cold chamber die casting

HOTCHAMBERDIECASTING

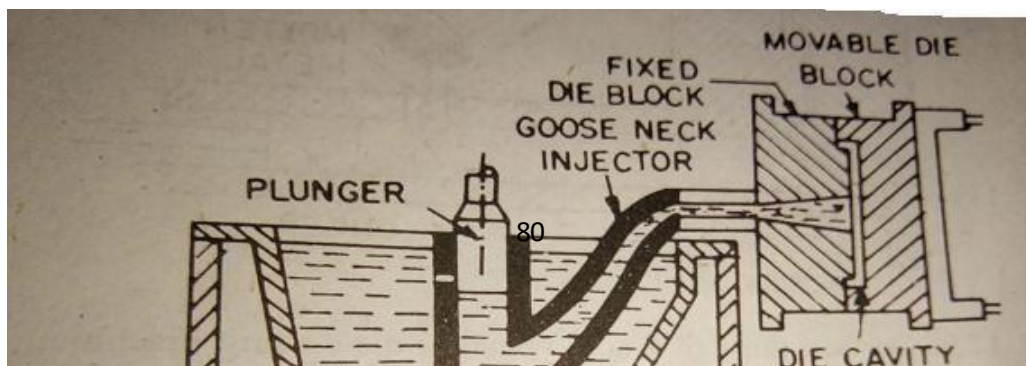

1. The melting unit or heating furnace for the liquid metal is an integral part of this die casting machine, that's why it is called hot chamber die casting machine.
2. The molten metal from the metal container is forced inside the die with the help of a plunger which operates hydraulically.
3. This plunger acts inside a cylinder formed at the end of a gooseneck type casting which is submerged in the molten metal.
4. A port is provided near the top of the cylinder to allow the entry of the molten metal into it. When the bottom of the plunger is above the port, the cylinder is connected to the melting pot through this port.
5. When the plunger moves down, it closes this port, and cuts off the metal supply. The molten metal is forced into the die through the injecting nozzle by the pressure applied by the plunger on the molten metal present in the gooseneck.
6. After a certain period of time, in the next cycle when the plunger moves up, the remaining molten metal in the nozzle falls back and when the plunger uncovers the port, molten metal fills the cylinder. Due to synchronisation of movable die with the movement of

plunger , during the upward motion of plunger, the movable die moves away and the casting is ejected.

7. Low melting point alloys (Zn based alloy)are generally cast in this machine.

COLDCHAMBERDIECASTING

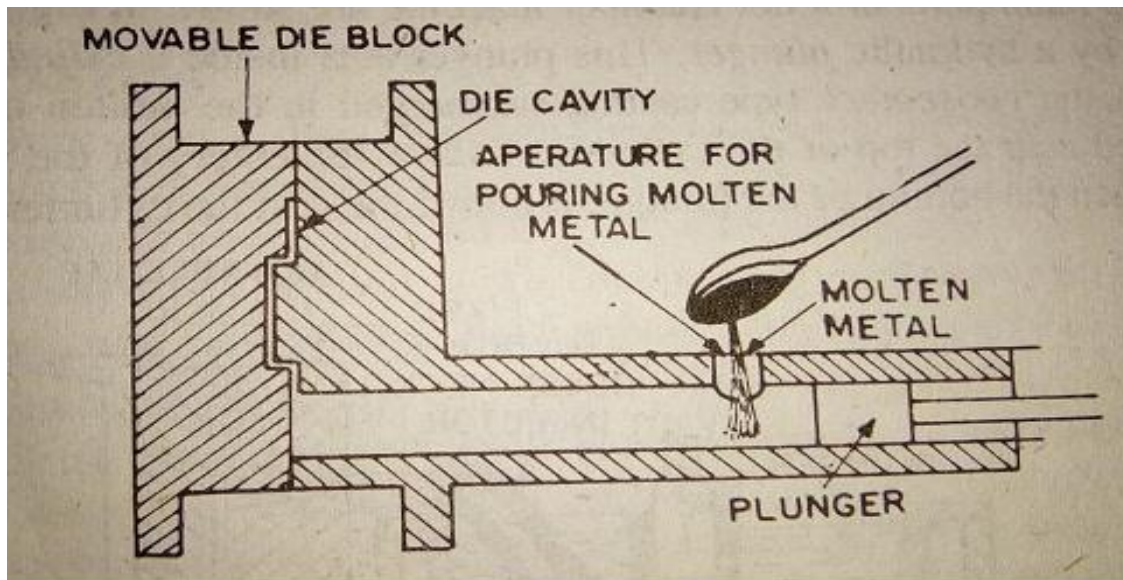

COLD CHAMBER DIE CASTING

1. In this machine the metal is melted separately in a furnace and transferred to this by means of small hand ladle.
2. After closing the die, the molten metal is poured into the horizontal chamber through the metal inlet and is forced into the die cavity by a hydraulic operated plunger.
3. After solidification the die is opened and the casting is ejected.
4. These machines are widely used for casting a good no. of aluminum alloys and brass. So in this process comparatively higher melting point alloys can be processed.

APPLICATIONS

- Carburetor, handlebar, different parts of scooter, motorcycle, and jeep.
- Other decorative items.

ADVANTAGES

1. Very small thickness can be easily cast.
2. High production rate.
3. Better surface finish.
4. Possible to obtain fairly complex casting.

DISADVANTAGES

1. Not suitable for all materials.
2. The die and the machine are very expensive.
3. The maximum size of the casting is limited.
4. Sometimes cold shut defects can be seen .

CENTRIFUGAL CASTING

- As the name suggests , the centrifugal casting process utilizes the centrifugal force developed by the rotation of the mold to distribute the molten metal into the mold.
- In other words, this is a process where the mold is rotated rapidly about the central axis when the metal is poured into it; because of the centrifugal force the molten metal is directed outwards from

the centre towards the inside surface of the mold, with high pressure.

- As a result of this a uniform thickness of metal is deposited all along the inside surface of the mold.
- During solidification, the impurities being lighter remain nearer to the axis of rotation. Greater accuracy and better physical properties of the casting are obtained in this process.

The centrifugal casting method can be classified as follows:

1. True centrifugal casting.
2. Semi-centrifugal casting
3. Centrifuging

True centrifugal casting

- In true centrifugal casting the axis of rotation of the mold and the axis of the casting are the same. The axis of rotation of the mold may be horizontal, vertical or inclined at an angle between 70° and 90° .
- End cores are usually used at the two ends of the mold to prevent the splashing of molten metal. The central hole through the casting is produced by the centrifugal force without the use of a central core.
- If the axis of rotation of the mold remains horizontal then the casting method is known as horizontal true centrifugal casting.

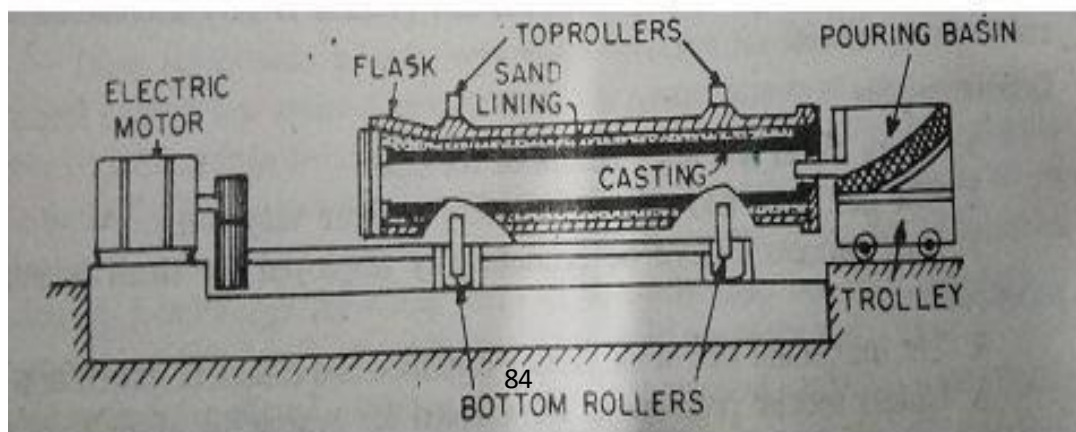

- As shown in the figure an outer metallic flask with rammed sand lining inside is used as mold and is rotated by two sets of rollers. A variable speed motor which is mounted at an end, is used to drive the rollers. Through the pouring basin, molten metal is poured and during pouring the mold is rotated at a slow speed.
- After the pouring is over, the mold is rotated at a very fast speed for even distribution of the metal and for proper directional solidification, wall thickness is controlled by the volume of molten metal poured into the mold.
- Pouring temperatures range between 1482°C to 1649°C and speed of rotation vary from 50 to 3000 revolutions per minute.
- In vertical and inclined axes true centrifugal casting methods, the axes remain vertical and at an angle between 70° to 90° respectively. Here the molten metal is poured towards the centre of the mold bottom.
- Convenience in metal pouring and ejection of casting is obtained but here the central hole produced is not truly cylindrical. This defect can be minimised by high spinning speed.

ADVANTAGES

- Sound and clean metal casting are obtained.
- In most of the cases, cores are not used to produce a central hole.

- Noneedofseparategatesandrisers.
- Productionrateisveryhigh.
- Thinsectionsandintricateshapescanbeeasilycast.
- Inspectionissimplifiedasinthescastingifanydefectoccurs,it is normally found on the surface of the casting.
- Thecastinghaveverygoodmechanicalproperties.
- Thepercentageofrejectsisverylow.

DISADVANTAGES

- Allshapescan'tbecastthroughthisprocess.
- Heavyinitialinvestmentisrequiredforthis type of casting.
- It'smaintenanceisexpensiveandskilledlabourisrequired.

CENTRIFUGING

- Thisisalsoknownaspresurecasting.This casting process is similar to true centrifugal casting process but in this case the axis of rotation and the axis of the mold donot coincide with each other.
- Here the molds are situated at a certain distance from the central vertical axis of rotation. A common central sprue and radial gates are used for feeding molten metal to the molds.

- Like semi centrifugal casting, here also the mold assembly is rotated about a vertical axis and the generated centrifugal force forces the molten metal from the central sprue into the mold cavity through the radial gates.

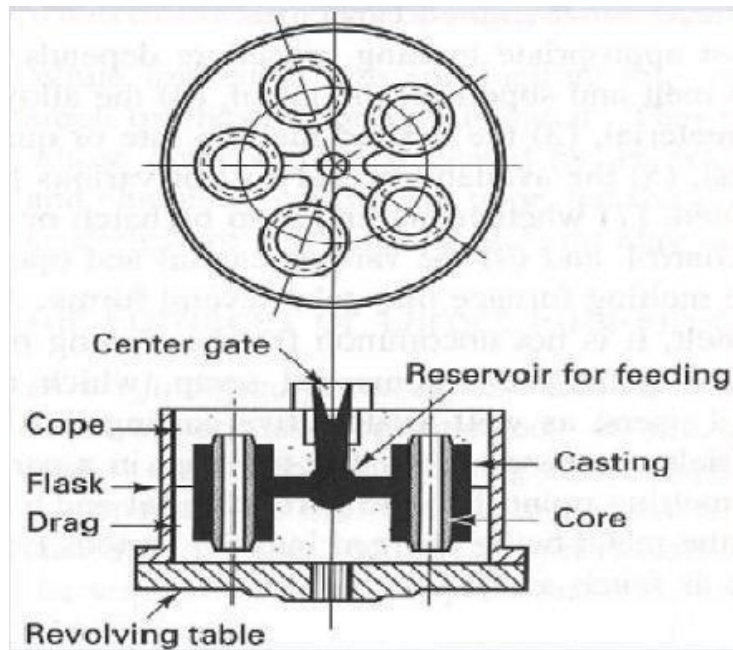

ADVANTAGES

- Shapes of castings don't carry any limitations.
- High rate of production can be achieved.

APPLICATION

- Horizontal true centrifugal casting is normally used for making hollow pipes, tubes, gun barrels, hollow bushes etc. which are symmetric with a concentric hole. Vertical or inclined axes true centrifugal casting is used for production of short length castings.

CASTING DEFECTS WITH THEIR CAUSES AND REMEDIES

● Various defects which commonly occur in casting are:

1. Blowholes
2. Porosity
3. Shrinkage
4. Misrun and cold shuts
5. Inclusions
6. Hot tears or hot cracks or pulls
7. Cuts and washes
8. Metal Penetration
9. Drops
10. Fusion
11. Shot metal
12. Shifts
13. Rattails or buckles
14. Swells
15. Hard spots
16. Runouts
17. Crushes
18. Warp

Blowholes: Appear as cavities in casting

Possible causes	Remedies
<ul style="list-style-type: none">a) Excess moisture content in molding sand.b) Rust and moisture on chills, chaplets and inserts used.c) Cores not sufficiently baked.d) Excessive use of organic binders.	<ul style="list-style-type: none">a) Control moisture content.b) Use clean and rust-free chills, chaplets and metal inserts.c) Bake cores properly.d) Use organic binders with restraint.

e) Molds rammed very hard.	e) Provide adequate venting in moulds and cores. f) Ram the moulds less hard.
----------------------------	--

Porosity: Appear in the form of microscopic pores

Possible causes	Remedies
<ul style="list-style-type: none"> a) High pouring temperature. b) Gas dissolved in metal charge. c) Less flux used. d) Molten metal not properly degassed. e) Slow solidification of casting. f) High moisture and low permeability in mould. 	<ul style="list-style-type: none"> a) Regulate pouring temperature. b) Control metal composition. c) Increase flux proportion. d) Ensure effective degassing. e) Modify gating and risering. f) Reduce moisture and increase permeability of mould.

Shrinkage: Appear in the form of voids due to volumetric shrinkage of molten metal during solidification.

Possible causes	Remedies
<ul style="list-style-type: none"> a) Faulty gating and risering. b) Improper chilling. 	<ul style="list-style-type: none"> a) Ensure proper directional solidification by modifying gating, risering and chilling.

Misrun: Appear in the form of incomplete casting as certain section of the mold remains unfilled. This defect is known as misrun

Possible causes	Remedies
<ul style="list-style-type: none"> a) Lack of fluidity in molten metal. b) Faulty design. c) Faulty gating. 	<ul style="list-style-type: none"> a) Adjust proper pouring temperature. b) Modify design. c) Modify gating system

Coldshuts:Discontinuitybetweentwostreamsof moltenmetal.

Possiblecauses	Remedies
a) Lackof fluidity inmolten metal. b) Faultydesign. c) Faultygating.	a) Adjust proper pouring temperature. b) Modifydesign. c) Modifygatingsystem

Inclusions:Theseinclusionsmaybeintheformof oxides,slag,dirt, sand and gas

Possiblecauses	Remedies
a) Faultygating b) Faultypouring. c) Inferior molding or core sand. d) Softrammingof mold. e) Rough handling of mold and core.	a) Modifygatingsystem b) Improvepouringtomimise turbulence. c) Useasuperiorsandhaving more strength. d) Provideharderramming. e) Takecareinhandling.

Hottearsorhotcrackorpulls

Possiblecauses	Remedies
a) Lackofcollapsibilityofcore. b) Lackofcollapsibilityof mold. c) Faultydesign d) Hardrammingof mold.	a) Improvecorecollapsibility. b) Improvemoldcollapsibility. c) Modifydesign. d) Providesofterramming.

Cutsand washes

Possiblecauses	Remedies
<ul style="list-style-type: none"> a) Low strength of mold and core. b) Lackofbinders in facing and core stand. c) Faulty gating 	<ul style="list-style-type: none"> a) Improve mold and core strength. b) Addmorebinderstofacing and core sand. c) Improvegatingsystem.

Metalpenetration

Possiblecauses	Remedies
<ul style="list-style-type: none"> a) Largegrainsizeandused. b) Softrammingofmold. c) Moldingsandorcorehave low strength d) Moldingsandorcorehave high permeability. e) Pouring temperature of metal too high. 	<ul style="list-style-type: none"> a) Usesandhavingfinergrain size. b) Provideharderramming c) Increase the strength to required extent. d) Reduce permeability with thehelpof(a)and(b)above. e) Suitably adjust pouring temperature.

Drops

Possiblecauses	Remedies
<ul style="list-style-type: none"> a) Low green strength in molding sand and core . b) Toosoftramming. c) Inadequatereinforcementof sand projections and core. 	<ul style="list-style-type: none"> a) Modifysandcompositionfor increased green strength. b) Provideharderramming. c) Provide adequate reinforcement to sand

	projections and cope by using nails and gagers etc.
--	---

Fusion

Possiblecauses	Remedies
a) Low refractoriness in molding sand. b) Faultygating. c) Too high pouring temperature of metal. d) Poorfacingsand.	a) Improverefractoriness. b) Modifygatingsystem. c) Use lower pouring temperature. d) Improve quality of facing sand.

Shot metal

Possiblecauses	Remedies
a) Too low pouring temperature. b) Excess sulphur content in metal. c) Faultygating. d) High moisture content in molding sand.	a) Use higher pouring temperature. b) Reducesulphurcontent. c) Modifygatingsystem. d) Reducemoisturecontent.

Shifts

Possiblecauses	Remedies
a) Worn-outorbentclamping pins. b) Misalignmentoftwohalves of pattern. c) Improper supportofcore. d) Improperlocationofcore.	a) Repairorreplacethepins. b) Repair or replace dowels causing misalignment. c) Provideadequatesupportto core. d) Locatethecoreproperly.

e) Faulty core boxes. f) Insufficient strength of moldings sand and core.	e) Repair or replace the core boxes. f) Increase strength of molding sand and core.
--	--

Rattails or Buckles

Possible causes	Remedies
a) Continuous large flat surface on casting. b) Excessive mold hardness. c) Lack of combustible additives in molding sand.	a) Break continuity of large flat surface by providing grooves and depressions. b) Reduce mold hardness. c) Suitably add combustible additives to sand.

Swells

Possible causes	Remedies
a) Too soft ramming of mold. b) Low strength of mold and core. c) Mold not properly supported.	a) Provide harder ramming. Increase strength of mold and core. Provide adequate support to mold.

Hard spots

Possible causes	Remedies
a) Faulty metal composition. b) Faulty casting design.	a) Suitably change the metal composition. b) Modify the casting design.

Runouts

Possible causes	Remedies
<ul style="list-style-type: none"> a) Faulty molding b) Defective molding boxes 	<ul style="list-style-type: none"> a) Improve molding technique. b) Change the defective molding boxes.

Crushes

Possible causes	Remedies
<ul style="list-style-type: none"> a) Defective core boxes producing over-sized cores. b) Worn out core prints on patterns producing under sized seats for cores in the mold. c) Careless assembly of cores in the mold. 	<ul style="list-style-type: none"> a) Repair or replace core boxes. b) Repair or replace core prints. c) Take adequate care in setting of cores in the mold.

Warping

Possible causes	Remedies
<ul style="list-style-type: none"> a) Continuous large flat surfaces on castings, indicating a poor design. b) No directional solidification of casting. 	<ul style="list-style-type: none"> a) Modify the casting design to break the continuity of the large flat surfaces and facilitate proper directional solidification.

POWDERMETALLURGY (FORMING)

Powder metallurgy is a metal forming process performed by heating compacted metal powders to just below their melting point.

Advantages of powder metallurgy

1. The powder metallurgy parts require very little finishing process.
2. Powder metallurgy process does not cause any wastage of material during processing.
3. Reasonably complex shapes which cannot be economically machined or casted can be produced by powder metallurgy.
4. It is possible to produce parts with a combination of metals and ceramic. Thus permits a wide variety of alloy systems.
5. Produces good surface finish.
6. Automation of the powder metallurgy process can be easily accomplished reducing the labor required.
7. This process provides controlled porosity.

Method of production using powder metallurgy technique

The basic stages of production are:

1. Production of metal powders.
2. Mixing or blending of the metal powders in required proportion.
3. Pouring of blended powder into die of desired shape and size.
4. Pressing and compacting the blended powder in the die.
5. Sintering the compacted parts in a controlled furnace atmosphere.
6. Secondary processing of the part, if required.

Production of powders

Methods of producing metal powders

Atomisation:

In this process the molten metal is forced through an orifice into a stream of air, water or inert gas. As it comes in contact with the stream, the molten metal solidifies into small particles of metal due to extremely rapid cooling.

In air and water atomization process metal oxides are formed but in gas atomization process the particles are not oxidized.

Gaseous reduction:

It consists of grinding the metallic oxide to a finely divided state and then reducing it by hydrogen or carbon monoxide, it is employed for metals such as iron tungsten nickel, cobalt and molybdenum.

Electrolysis process:

In this process of producing powder, the condition of electrodeposition is controlled in such a way that a soft spongy deposit is formed which is then pulverized to form powder.

Milling and Grinding or Mechanical pulverisation

This process involves pulverizing the metal by crushing or impact through ball mills or stampers. By this process the metal breaks down into small particles. The ball mill is employed for brittle materials while stamp mill for ductile materials. The cost is generally high and the powders produced by these methods are usually treated to remove the cold hardening received in this process.

Shotting : It consists of dropping the molten metal through a sieve into water to produce spherical particles. This process can be applied to most

of the metals, but size of the particles is usually large. This may be followed by mechanical means to produce finer particles.

Machining: It is mainly used for producing magnesium and beryllium particles. The particles produced are, however, coarse, which can be converted into fine powder through ball milling and impact grinding.

Other methods which are used occasionally are:

- (i) Chemical precipitation from solution
- (ii) Vapour condensation widely used for zinc.
- (iii) Granulation process: It consists of rapid stirring of molten metal during cooling. This process produces a relatively coarse powder with a high percentage of oxide.

Blending or mixing:

Blending is not required, when only one metal powder is used to produce the part. When different metal powders are used or when nonmetallic particles are added to impart certain properties, blending or mixing of constituents are required. The process consists of a thorough mixing of the constituents either wet or dry. Wet mixing reduces dust and minimizes the dangers of explosion. Lubricants are added during blending to reduce friction during pressing. Common lubricants are graphite, stearic acid and lithium stearate.

Briquetting or compacting

It is the process of converting loose powder into a green compact of accurate shape and size. It is done in steel dies and punches. Here two punches are employed, one from the top and the other from the bottom of the powder.

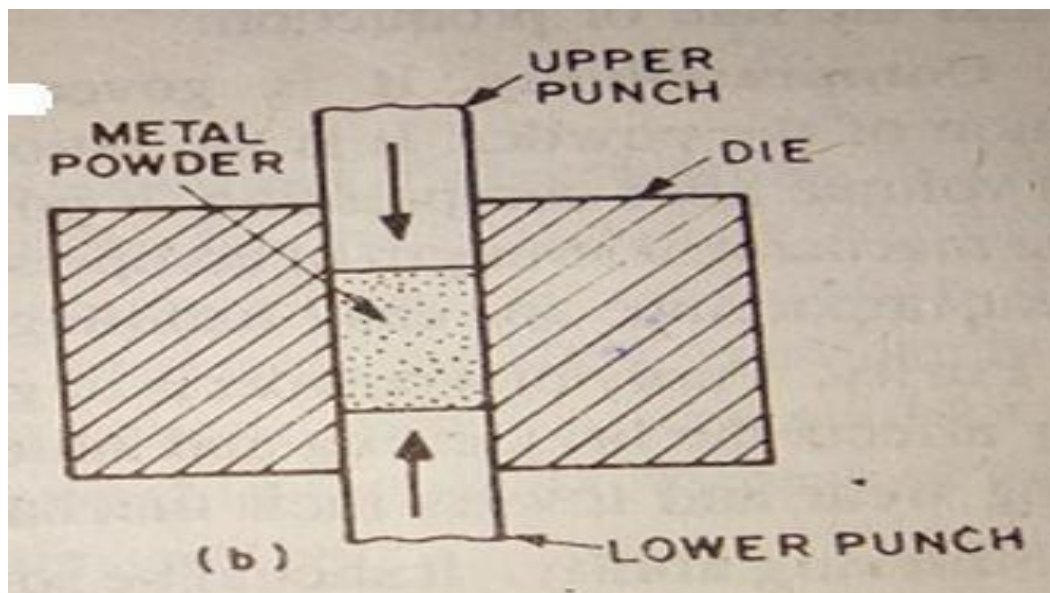

The dies and punches are highly polished and have minimum clearance between them to maintain proper alignment. The punches should be sufficiently tough. High carbon steel, high chromium-vanadium steel and tungsten carbide are the principal die materials.

During the process, the powder is compressed to nearly one-third of its original volume. Either mechanical or hydraulic or a combination of both presses are used for this purpose.

The metal powder can also be compacted into the form of a sheet by passing a continuous stream of powder through a pair of rolls rotating in opposite directions. It is known as roll pressing.

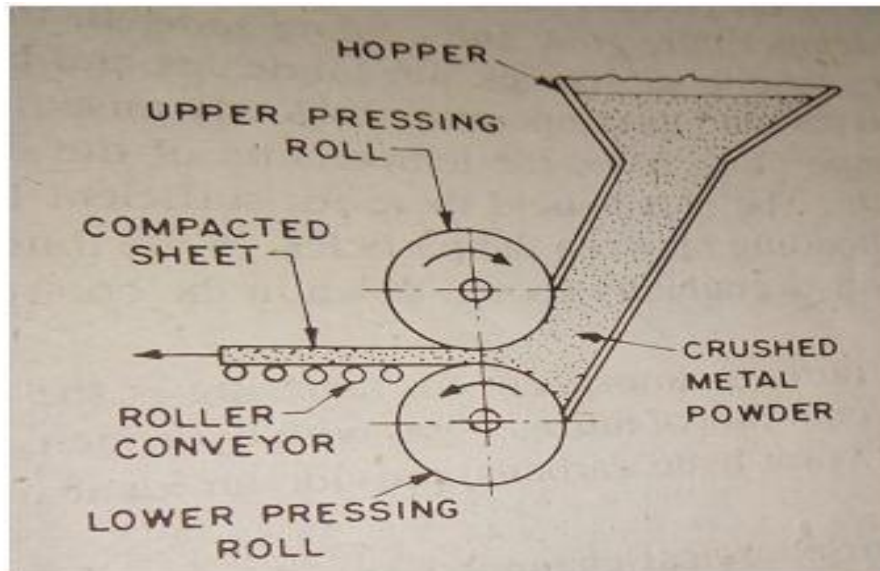

Use of roller pressing process for producing sheets through powder metallurgy process

Presintering

Pre sintering is the process by which the green compact is heated to a temperature below the sintering temperature. It increases strength of green compact and removes the lubricants and binders added during blending. For materials which can't be machined after sintering, the machining is done after pre sintering. Example is tungsten carbide.

Sintering

Sintering of briquetted parts is done in large continuous furnaces having controlled atmosphere for protection against oxidation and other chemical reactions. The important factors governing sintering are temperature, time, and atmosphere.

The sintering temperatures for most materials lie between 70 to 80 percent of their melting point. It is, however, quite high in case of

ceramics i.e 90 percent of melting point. In case of mixture of two or more material the sintering temperature of the compacted part may be more than the melting point of some of the constituent.

Sintering operation has three distinct stages. To carry out these three stages, most of the furnaces have three distinct areas.

These are:

1. Purge or burn off chamber.
2. High temperature zone.
3. Cooling zone.

In the first stage, i.e in the purge chamber, volatile substances, air, lubricants and binders are burnt off from the compacted part as its temperature is slowly raised.

In the second stage, i.e. In the high temperature zone, the temperature is raised to sintering temperature. The part is held here for sufficient time to complete solid state diffusion and bonding between the particles.

In the third stage, i.e. in cooling zone the sintered part is gradually cooled down in the controlled atmosphere of the furnace.

The furnace atmosphere for sintering is either neutral or reducing. A mixture of nitrogen gas with hydrogen, methane provide an ideal reducing atmosphere for this operation.

By sintering, the strength, thermal and electrical conductivities and compact density of the material increases.

In brief, the main objectives of sintering are:

- a) Achieving high strength.
- b) Achieving good bonding of powder particles.

- c) Producing a dense and compact structure.
- d) Producing parts free of oxides.
- e) Causing metallurgical diffusion and facilitate alloying of constituent materials.
- f) Obtaining desired structure and improved mechanical properties.

Secondary processes

To achieve close tolerances and better surface finish, secondary processes are performed. These processes include sizing, coining, machining, plating, heat treatment etc.

Economic of Powder Metallurgy

Powder metallurgy's cost competitiveness against other technologies is based on two factors.

1. Lower energy consumption.
2. Maximum utilisation of raw material.

However, the process will be economical if:

1. Relatively small and high parts are to be manufactured due to limitation of powder metallurgy compaction presses.
2. The thickness or height of the part must be small.
3. A large no of products is to be produced. More over down time between investment of capital to install equipment and production of jobs is to be minimized and batch size must be large to minimize the tool change over time.

PRESSWORK

Press work is a method to form sheet metal into various shapes by using a press machine . A press machine has two parts. The upper part which is fastened to the ram, hits the workpiece, during pressing and the lower part of the machine press contains a tool which corresponds to the upper part. The upper part is known as the punch and the lower part is known as the die and the total unit is known as Die assembly or Dieset.

Punch:

The male member of the die assembly is called punch. It is usually that part of the unit which is fastened or attached to the RAM and is forced into the die.

Die:

The female member of the die assembly is called die. It is usually rigidly held on the bed of the press. It carries an opening in the perfect with the punch through which the punch enters into the die alignment.

Types of die:

1. Single operation die:

These are designed to perform only single operation in each stroke of the RAM.

2. Multi operation die:

These are designed to perform more than one operation in each stroke of the RAM.

Single operation dies are further classified as:

• Cutting dies

These dies are used to cut the metal. They utilize the cutting or shearing action. The common cutting dies are blanking dies, piercing, perforating dies, piercing or perforating dies, notching, trimming dies.

• Forming dies

These are not metal cutting dies but they change the configuration of blank to form desired shape without metal removal, this includes bending, drawing & sewing die.

Multioperationdiesareclassifiedinto

- Compounddies:

In which two more cutting operation can be performed in a single stroke of the RAM or at a single action.

- Combinationdies

In this dies a combination of cutting or some other operation can be performed at a single station.

- Progressivedies

Thisdiecarriesanoofstationinazeroaseparateoperationisperformedon eachstationandtheworkpieceshiftsintostationtothenextoneineachstrokeof the RAM.

Differentcuttingoperations

Trimming;Shaving;Burnishing Trimming:

Trimmingisanoperationusedforremovingexcessmetal,irregularoutlines andwaveedgesetc.fromthe walls.

Shaving:

Shaving is also a similar operation donefor finishing and sizing theroughedges on the blanks.

Burnishing:

Burnishingusuallyfollowsshavingorsmoothingthesharpenededges.

TYPESOFPUNCH:

Punchesareclassifiedas;

1. Planepunch
2. Pedestalpunch
3. Punchesmountedonpunchplate

Planepunch:

These are the simplest type of punches. These are made of solid tool steel blockandaredirectlymountedtothepunchholder,thepunchesarejoined

together by means of dowels and screw. These must be large enough to provide necessary space for dowels and screws as well as the necessary strength to withstand the punching force. The length and width of this punches should be greater than the height of the punch.

The main advantage is the economy in punch construction.

Pedestal punches:

It is also called flanged punch or shoulder punch these are characterized by large base surface compared to the cutting face. The flanged portion which is an integral part of the punch offers excellent stability of the punch.

The method of mounting is similar to plane punch in fact the flange portion of the length and the width of the base should be larger than or equal to the highest of the punch. The flange thickness and the fillet radius are to be largely provided with stand the larger forces.

Punches mounted in punch plate

A punch plate is used generally to locate and hold the punch in position.

A simple method of assembling a plane punch in the punch plate as shown.

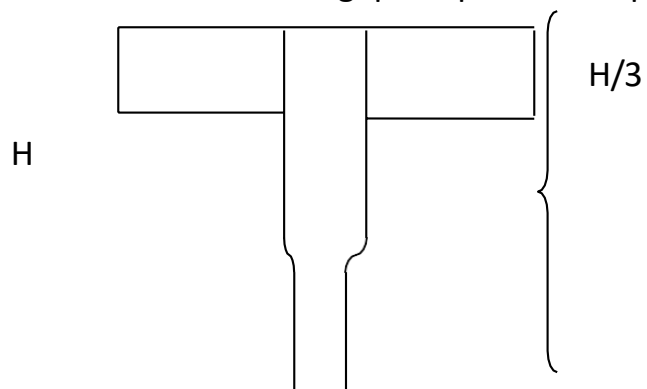

Here the punch has uniform cross section throughout and each attached to the punch holder by means of screw. The punch plate has the necessary holes for locating the punch properly.

Perforator type punch

Punches whose cutting face die is less than 25mm are called perforator. The punches need not be round but the inscribe circle of the punch should have a die less than 25mm.

The simplest and the most common perforator is the step head type mounted in a punch plate by means of step head.

If cutting face is round than assembling the punch in any orientation is possible.

Quill punch:

For parsing very small holes less than 6mm die it is desirable to provide extra support to the punch shank by means of a closely fitted quill, these are more expensive if made individually because of the close heating required between the punch and quill size, therefore they are mass produced in various standard sizes.

Progressive dies:

The progressive dies perform two or more operations simultaneously a single stock of punch press so that a complete component is obtained for each stroke. The place where each of the operation carried out are called station.

At the start of the operation the sheet is fed into the first station after undergoing the operations at this station the ram of the press moves to the top and the stroke is advanced from the 1st station to the second station the distance moved by the strip from station 1 to station 2 so that it is properly registered under the station is called advanced distance another variable called the field distance is the amount of stock fed under the punch when the RAM comes to the next stroke

Progressive dies contains a large number of stations it is generally performed to have a piercing operation first in the sequence and a blanking operation in the end to get the final component .

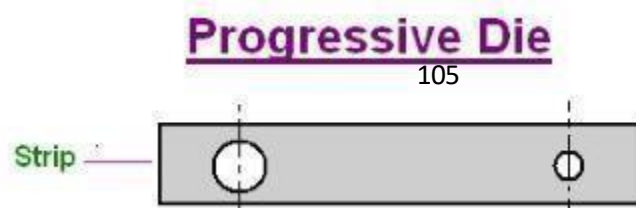

Compound die

In a compound die all the necessary operations are carried out at a single station in a single stroke of the RAM to do more than one set of operations. A compound die consists of the necessary set of punches and dies. During the part of the stroke piercing of holes is done in the stock and on further travel and blanking operation is done. For the blanking operation the punch used for the blanking operation the punch used for piercing becomes a die. In other words blanking is done in a direction opposite to piercing. Compound dies are slower than the corresponding dies in operation but higher tolerances can be achieved in them. Compound dies are progressive dies. This is mainly because the part located in one position undergoes all the operations. Also in compound dies small strips can be used whereas in progressive die very long strips are required to cover all the stations.

Compound Die

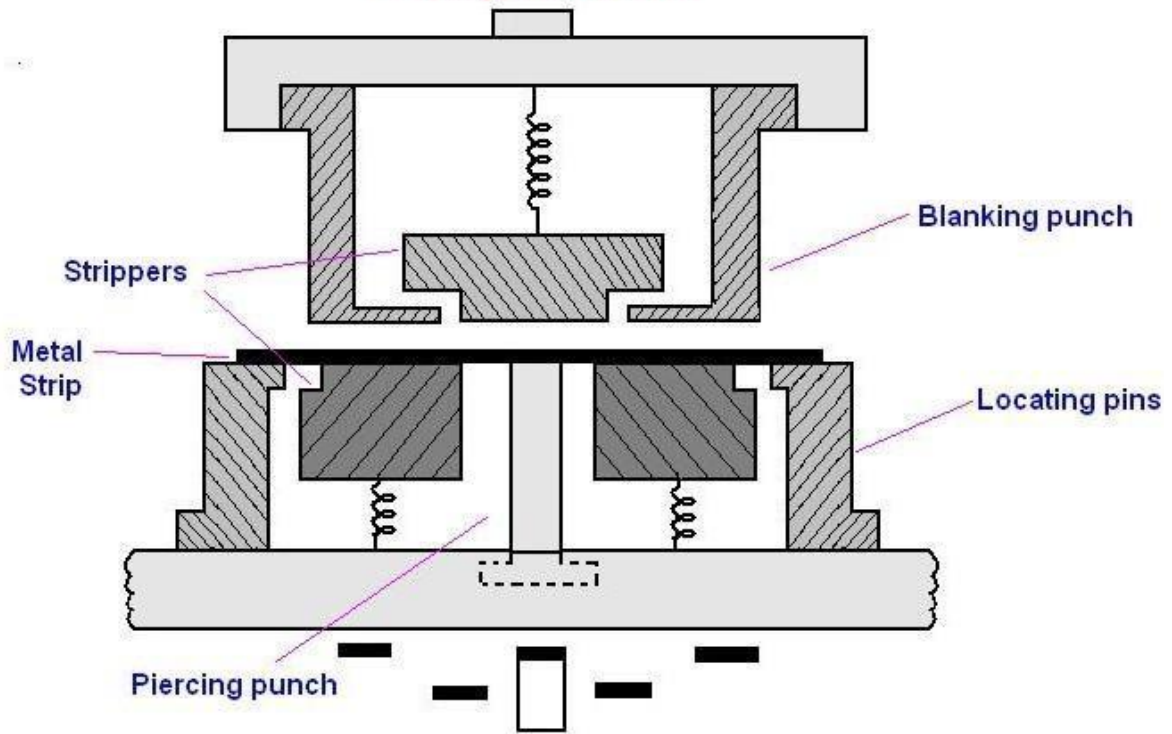

JIGS AND FIXTURE

Jigs and fixture are the devices which helps in increasing rate of production of identical parts and simultaneously reducing the human effort required for producing this parts.

Difference between jigs and fixture

Jigs:

A jig is a special design metal plate box or a fabricated structure into which the component is held one after the other in identical positions to perform identical machining operation.

The jig provides a positive and trace identical locations to all the successive components and guides the tool as well as the work piece in the same way in all the respective operations so that the machining is done in exactly the same manner in all the operations.

Fixture:

A fixture does more or less the same work as a jig in that it holds and locates the successive work piece in identical position but differs from a jig in that it does not guide and locate the tools. The tool has to be adjusted separately a fixture is usually of a massive and heavier construction than a jig and is fixed or bolted to the table of the machine. This shows that a jig holds and locates the work piece, guides the cutting tools to the work and normally is not fixed in the machine table against this a fixture only holds and locates the work piece, does not guide the tool and is fixed to the machine table. Jigs are generally used in drilling tapping whereas the fixtures are employed in milling grinding turning and shaping.

Degree of freedom of moment or principle of location:

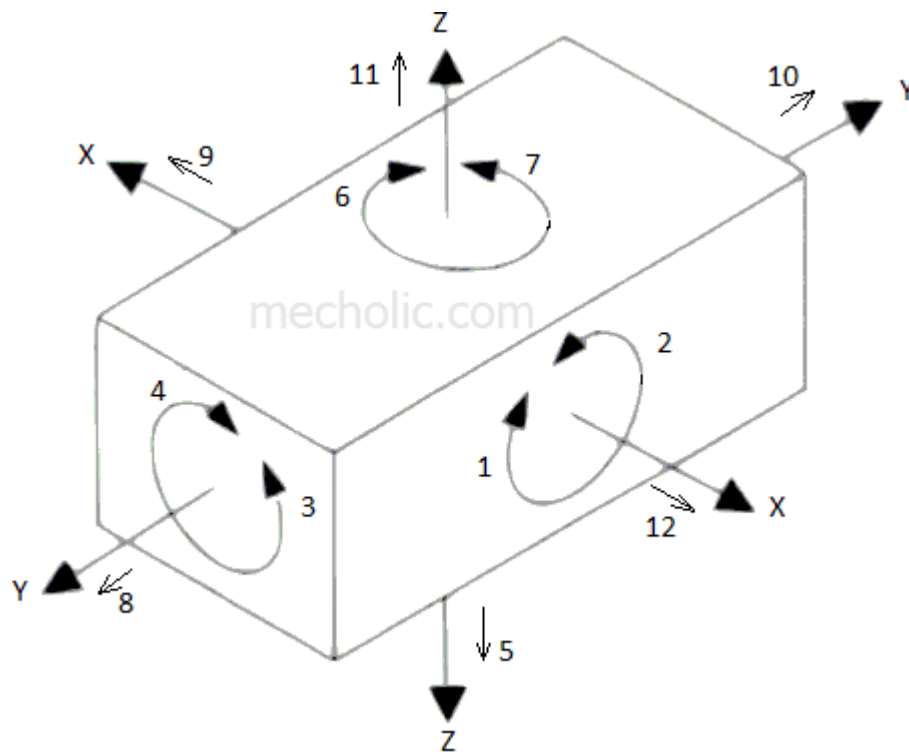

Suppose the workpiece is a cube having perfectly flat and true faces and is located in space to act as a free body, let us consider 3 mutually perpendicular axes x-x, y-y, z-z pass through the center of the body. Now this free body in space can have the following movement.

Translational movement
 Along the x-axis
 Along the y-axis
 Along the z-axis

rotational movement
 along the x-axis
 along the y-axis
 along the z-axis

Thus a free body in space has 3 degrees of freedom of straight line movement and 3 degrees of freedom of rotation these are called 6 degrees of freedom movement of a free body in space.

But in some cases both translational and rotational in opposite directions along the 3-axis as 2 different degrees of freedom thus making total no. of degrees of freedom

movements (for translational back and forth and for rotation either clockwise or anti clockwise).

So in finally locating a work piece in a fixture each to constrain with the help of suitable locating pins and by means of clamping in such a way that all or as many as degree of freedom are checked only then, it can be ensured that the work piece will not dislocate from its position during the operation and therefore the operation will be complicated with the desired accuracy.

Main elements of jigs and fixture

Body:

It is a plate, box or frame type structure in which the component to be machined are located.

Locating element:

These elements locate the work piece in proper position in relation to the cutting tool.

Clamping elements:

These elements locate the work piece in the located position.

Guide and setting elements:

These elements guide the cutting tools in case of jig and held in proper tool setting in case of fixture.

Positioning element:

These elements include different types of fastening devices which are used to secure the jig or fixture to the machine at proper position.

Indexing element:

Many work pieces may have to be indexed to different positions in order to perform machining operations on different surfaces on different locations.

The principle of 6 point of location 3-2-1-point location

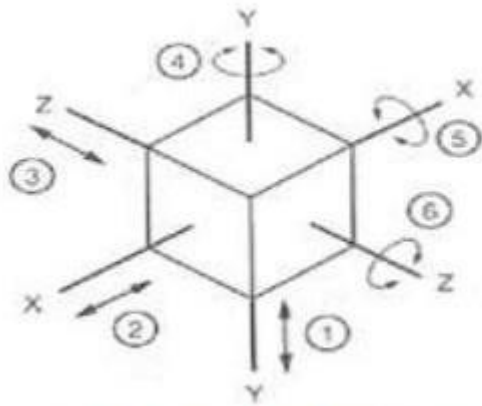

SIX DEGREES OF FREEDOM

3-2-1 PRINCIPLE OF LOCATION

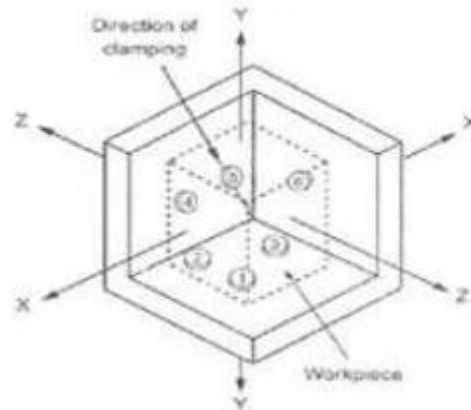

Six point Location Principles

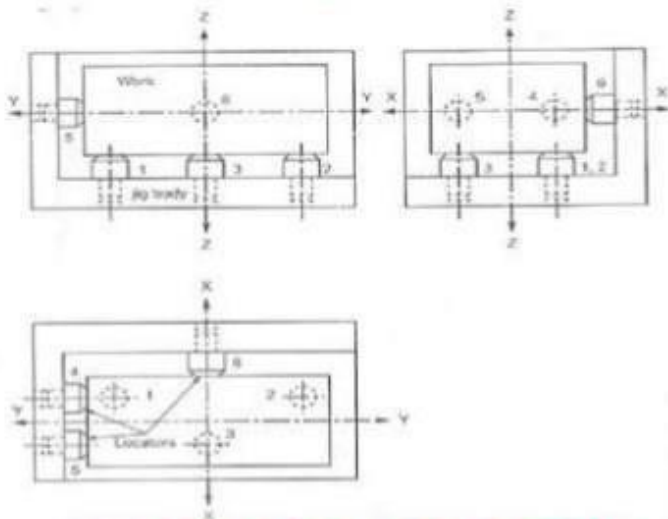

Pin 1,2 and 3
for z-z axis translation
y-y axis rotation
x-x axis rotation

Pin 4 and 5
for y-y axis translation
z-z axis rotation

Pin 6
for x-x translation

3-2-1 PRINCIPLE OF LOCATION

According to this principle a work piece can be completely restricted or hold by providing 3 location points in one plane, 2 location points in 2nd plane and 1 location point in 3rd plane in fig. shown a cube is supported at 3 round faces at the bottom by two round faces on one side face and by 1 round face on the other side.

With this type of location of the object, it is evident that the component cannot rotate about any one of the 3 axis i.e. x-x, y-y, z-z. It is 3 D.O.F of movement 4-5-6 are constrained also due to the 3 supporting pins at the bottom. The work piece cannot move downward due to two pins on the left side. It cannot move leftward and due to the pin at the rear side. It cannot move backward. All these possible movements having been restrained the only free directions of movement remaining to be restrained for complete location, now at the forward movement along x-x axis right ward movement along z-z axis and upward movement along y- y axis. If effort is made to provide pins in front top and right side to arrest these remaining directions of 3 movements, the jig and fixture will take the shape of a closed box and it will not possible to load or unload work piece therefore these 3 degree of freedom are restrained by means of clamping devices this is known as principle of 6 points of location 3-2-1-point location.

Advantages of jigs and fixture:

- They enable easy means for manufacture of interchangeable parts and thus facilitated easy and quick assembly.
- Pre machining operation like marking, measuring etc. required in case of individual parts are totally eliminated with the use of jigs and fixture.
- Once a properly designed jigs or fixture is setup in position, any number of identical parts can be produced without any additional setup.
- Production capacity is increased with their use because any no. of parts can be produces in a single setup.
- They enable quick setting in proper location of work. Hence the work handling time is reduced.
- They occur a clamping rigidity. Therefore, higher speed, feed and the depth of cut can be used for machining.
- Because of automatic location of the work and guidance of the tools, the machining accuracy is increased.
- The parts produced with their use are very accurate. As such, the expand each other due to inspection quality control of finished components is considerably reduced.

- Their use enables easy machining of complex and heavy components because such parts can be rigidly held in proper location for machining in jigs and fixture.
- Also their use facilitated deployment of less skilled level because setting of tools and work pieces not manual there by effecting saving and labor cost.
- Thus no considerable reduction in manual handling operation consequently, there is a large reduction fatigue to the operator
- Their use facilitated a partial or nearly full automation of the operations cycle, there by effecting a substantial reduction in the overall production cost.

Types of jigs

1. Drilling jigs
2. Boring jigs

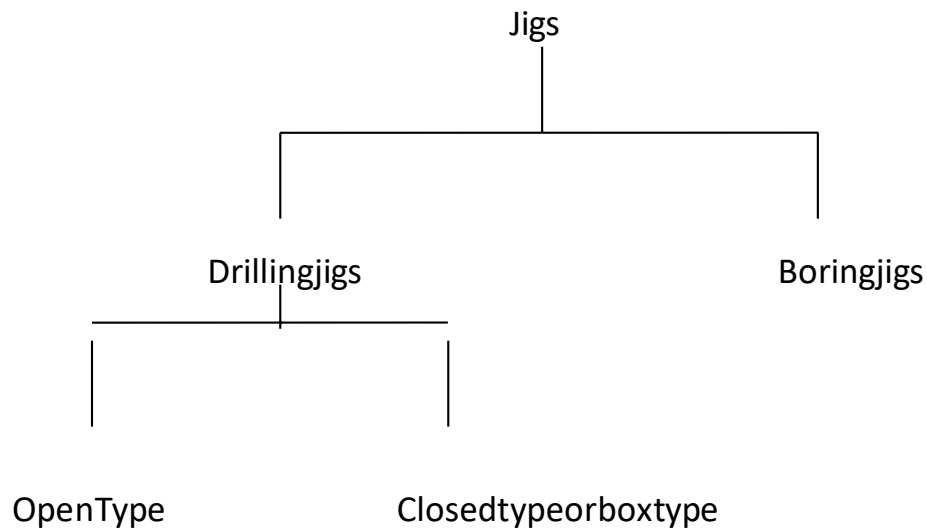

Types of drilling Jigs:

- Template jig
- Plate type jig
- Diameter jig
- Box type jig

Plate jigs:

This is an improvement over template jig. A plate jig is a template jig with an added clamping arrangement. A plate having drill bushes and suitable means to hold and locate the work so that it can be clamped to the plate and holes drilled directly through the bushes in correct position.

Box type jigs:

It is named so because of its box shape construction closed from most of the sides such jigs are normally designed and used for those component which carry an occurred shape and need machining more than one plane such components are usually difficult to be held or supported during the operation by hand or ordinary jigs of other types. They need a very rigid support from many sites which can be provided only by box type jigs.

Template jigs:

This is the simplest type of drilling jigs. It is simply a plate made to the shape and size of the work piece with the required a number of holes made in it accurately. It is placed on the work piece and the holes in the work piece will be made by drill, which will be guided through the holes in the template.

Diameter type jigs:

A diameter type jig is used for cylindrical work piece. It encloses the work piece in 'v' shape groove. The diameter jig may have a cover person that contains guide holes for drill operation.